

Mitsubishi Electric Research Laboratories (MERL)

Annual Report

July 2007 through June 2008

TR2008-00

(Published July 2009)

Welcome to Mitsubishi Electric Research Laboratories (MERL), the North American corporate R&D arm of Mitsubishi Electric Corporation. In this report, you will find descriptions of MERL and our projects.

This work may not be copied or reproduced in whole or in part for any commercial purpose. Permission to copy in whole or in part without payment of fee is granted for nonprofit educational and research purposes provided that all such whole or partial copies include the following: a notice that such copying is by permission of Mitsubishi Electric Research Laboratories; an acknowledgment of the authors and individual contributions to the work; and all applicable portions of the copyright notice. Copying, reproduction, or republishing for another purpose shall require a license with payment of fee to Mitsubishi Electric Research Laboratories. All rights reserved.

Copyright © Mitsubishi Electric Research Laboratories, 2009
201 Broadway, Cambridge, Massachusetts 02139
617.621.7500

Production:

Karen Dickie, Janet O'Halloran, Janet McAndless, Richard C. Waters

Table of Contents

Mitsubishi Electric Research Laboratories.....	1
Awards and Commendations	7
Technical Staff.....	9
Publications.....	21
Research.....	33
Digital Communications	35
Multimedia	43
Data & Sensor Systems.....	49
Imaging	53
Mechatronics	61
Algorithms.....	63

Mitsubishi Electric Research Laboratories

Mitsubishi Electric Research Laboratories (MERL) is the North American subsidiary of the corporate research and development organization of Mitsubishi Electric Corporation. MERL conducts application-motivated basic research and advanced development in communications, image/video processing, data analysis and mechatronics technology.

MERL's mission—our assignment from Mitsubishi Electric—is twofold.

- Generating new technology in areas of importance to Mitsubishi Electric.
- Significantly impacting Mitsubishi Electric's business: using our technical expertise in partnership with organizations in Mitsubishi Electric to produce new and improved products in Mitsubishi Electric's main areas of business.

MERL's vision—our goal for ourselves—is also twofold.

- To be one of the world's premiere research laboratories, significantly advancing the frontiers of technology and making lasting impacts on the world.
- To be the prime source of technology for Mitsubishi Electric in our areas of expertise.

MERL focuses on five principal technology sectors:

Digital Communications - featuring wired & wireless transmission technology & networking.

Multimedia - featuring speech interfaces and the encoding, decoding & analysis of video.

Data & Sensor Systems - featuring data analysis and equipment condition monitoring.

Imaging - featuring computer vision algorithms and the observation of people in images.

Mechatronics - featuring advanced control of electro-mechanical systems.

An Algorithms group supports all five sectors, developing fundamental algorithms.

MERL is small enough to be agile and flexible in the dynamic marketplace of ideas. However, we gain leverage from the size, reputation, and diversity of our strong global parent. We turn our technical achievements into business successes by partnering with Mitsubishi Electric's business units and with other labs in Mitsubishi Electric's global R&D network.

We are strongly involved in the R&D community and standards activities, maintaining long-standing cooperative relationships with a number of research universities including MIT, CMU, Stanford, Georgia Tech, and Harvard. We encourage our staff to be involved in their professional communities via conferences, papers, and continuing professional development.

MERL's output ranges from papers and patents, through proof-of-concept hardware and software prototypes, to modules for industry-first products. The headquarters operation includes an in-house patent department to speed the filing of patents.

This annual report is a snapshot of MERL's web site. For additional and updated information please visit "<http://www.merl.com>".

Dick Waters
President, MERL

MERL Organization

MERL is organized as six groups centered on technology areas, which collaborate closely to achieve groundbreaking results. We use a relatively flat organization to enhance the opportunities for collaboration within MERL. The five members of the top management team work closely together, guiding all aspects of MERL's operation.

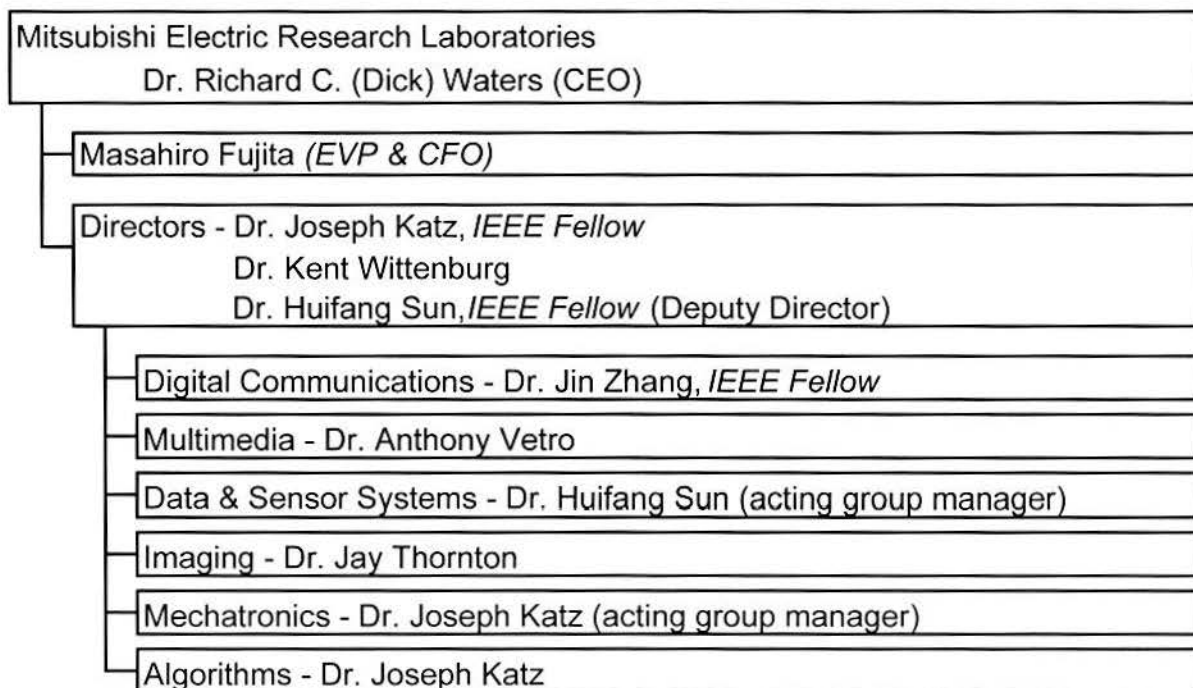

Richard C. (Dick) Waters *Ph.D., MIT, 1978*
President, Chief Executive Officer & Research Fellow

Dick Waters received his Ph.D. in artificial intelligence (AI). For the next 13 years he worked at the MIT AI Lab as a Research Scientist and co-principal investigator of the Programmer's Apprentice project. Dick was a founding member of MERL's Research Lab in 1991. As a MERL researcher, his work centered on multi-user interactive environments for work, learning, and play. For this work, he was made a MERL Research Fellow in 1996. In December 1999, he became CEO of MERL as a whole. In addition to his duties at MERL, Dick is currently a member of the board of directors of the Computing Research Association.



Masahiro Fujita *M.S., The University of Tokyo, 1983*
Executive Vice President, Chief Financial Officer & Chief Liaison Officer

Masahiro Fujita joined Mitsubishi Electric's Industrial Electronics & Systems Laboratory in 1983 where he developed motion control technologies for industrial robots and other equipment. He moved to the Factory Automation Business Unit's Nagoya works in 1999. He transferred to the Advanced Technology R&D Center in 2002 where he rose to Senior Manager of the Mechatronics Department, before coming to MERL in 2008.



Joseph Katz *Ph.D., California Institute of Technology, 1981*
Vice President & Director

After working at Caltech's Jet Propulsion Laboratory for a number of years, Joseph Katz went to Symbol Technologies, where as Senior VP of R&D he participated in, initiated, and led projects in a wide range of technologies, including barcode/RFID data capture, optics, imaging, signal processing, computing, networking, security, biometrics, and communications. He joined MERL's management in 2004.



Kent Wittenburg *Ph.D., University of Texas at Austin, 1986*
Vice President & Director

Kent Wittenburg performed research at the Microelectronics and Computer Technology Corporation (MCC), Bellcore, and Verizon/GTE laboratories. His research focused on Human-Computer Interaction (HCI) technologies and he managed groups in natural language interfaces and Internet technologies. He joined MERL in 2001 as the leader of speech and HCI research and was promoted to Director in 2002. He is a Senior member of the ACM.



Huifang Sun *Ph.D., University of Ottawa, 1986*
Vice President, Deputy Director & Research Fellow

After four years as a Professor at Fairleigh Dickinson University, Huifang Sun moved to the Sarnoff Research Laboratory in 1990 becoming Technology Leader for Digital Video Communication. In 1995, Huifang joined MERL as the leader of our video efforts, becoming a Deputy Director in 1997. In recognition of his productive career in video processing Huifang was made an IEEE Fellow in 2001. He was made a MERL Research Fellow in 2003.

Mitsubishi Electric

One of the world's largest companies, Mitsubishi Electric Corporation (Mitsubishi Electric) has \$40 billion in annual sales and \$2.7 billion in operating profits in 2007, and more than 100,000 employees around the world.

Mitsubishi Electric is composed of a wide range of operations. The primary business units are listed below.

Mitsubishi Electric Corp.
Information Systems & Network Services IT Systems, Information Security/Encryption Systems, Business Solutions
Public Utility Systems Government Systems, Transportation Systems, Very Large Display Devices
Energy & Industrial Systems Electrical Generators, Power Transmission and Distribution Equipment
Building Systems Elevators, Escalators, Building Monitoring /Security/Management Systems
Electronic Systems Satellites, Radar Systems, Antennas, Electronic Toll Collection Systems
Communication Systems Wired & Wireless Communication/Broadcasting Equipment and Systems
Living Environment & Digital Media Equipment Televisions, DVD Recorders, Air Conditioners, Solar Power Generation Systems
Factory Automation Systems Programmable Logic Controllers, Inverters, Servo-motors, Processing Machines
Automotive Equipment Automotive Electrical Equipment, Car Electronics/Multimedia, Car Mechatronics
Semiconductor & Device Optical Devices, High-Frequency & High-Power Semiconductors

Together, these ten business units produce approximately three quarters of Mitsubishi Electric's revenue. Due to the wide applicability of MERL's research, MERL works with them all.

It is worthy of note that there are over 30 major independent companies in the world that use the word "Mitsubishi" in their names. These companies include Mitsubishi UFJ Financial Group, Mitsubishi Corporation, Mitsubishi Heavy Industries, Mitsubishi Chemical Holdings and Mitsubishi Motors, all of which are also among the world's largest companies. They have shared roots in 19th century Japan; however, they have been separate for many years and Mitsubishi Electric has been separate from all of them since its founding in 1921.

Mitsubishi Electric's US Operations

A significant part of Mitsubishi Electric's sales are in North America and many of Mitsubishi Electric's business units have North American subsidiaries. MERL seeks to work directly with these subsidiaries, particularly when they have substantial local design and manufacturing as well as sales. The largest US operations are listed below.

Mitsubishi Digital Electronics America, Inc. (Los Angeles, Mexicali MX)
High Definition Projection Televisions, DVD Recorders

Mitsubishi Electric Automotive America, Inc. (Detroit, Mason OH)
Alternators, Ignition Coils, Automotive Electronics

Mitsubishi Electric United States, Inc. (Los Angeles & other cities)
Semiconductors, Air Conditioners, Elevators, Photovoltaic Panels

Mitsubishi Electric Power Products, Inc. (Pittsburgh)
Power Transmission Products

Mitsubishi Electric Automation, Inc. (Chicago)
Factory Automation Equipment

Mitsubishi Electric Corporate R&D

Mitsubishi Electric has a global R&D network comprising five laboratories. The chart below summarizes the primary activities of these labs. MERL collaborates with all of these labs.

Corporate R&D Headquarters (Tokyo)

Advanced Technology R&D Center (Amagasaki & Nagaokakyo, in greater Osaka)
Power Electronics, Electro-mechanical, Ecology, Energy, Materials, Devices, Systems and Imaging Technologies

Information Technology R&D Center (Ofuna, in greater Tokyo)
Information, Communications, Multimedia, Electro-Optic and Microwave Technologies

Industrial Design Center (Ofuna, in greater Tokyo)
Product, Interface and Concept Design

Mitsubishi Electric Research Laboratories, Inc. (Boston)
Communications, Multimedia, Data Analytics, Imaging and Mechatronics Technologies

Mitsubishi Electric R&D Centre Europe, B.V. (Rennes, France & Guildford, England)
Communications, Digital Video, Energy & Environment Technologies

Awards and Commendations

The high caliber of MERL's research and researchers is evident in a variety of ways. Four are highlighted below. The first is the members of our staff that are Fellows of technical societies. The second and third are best paper awards and technology awards received from outside organizations. The fourth is awards received from Mitsubishi Electric for MERL's contribution to its products. Listed below are achievements and awards for the period of this Annual Report.

Current Technical Society Fellows

Dr. Joseph Katz, Fellow Institute of Electrical and Electronic Engineers
Dr. Joseph Katz, Fellow Optical Society of America
Dr. Andreas F. Molisch, Fellow Institute of Electrical and Electronic Engineers
Dr. Huifang Sun, Fellow Institute of Electrical and Electronic Engineers
Dr. Jin Zhang, Fellow Institute of Electrical and Electronic Engineers

Best Paper Awards

Wren, C.; Ivanov, Y.; Kaur, I.; Leigh, D.; Westhues, J., "SocialMotion: Measuring the Hidden Social Life of a Building", *Third International Symposium on Location- and Context-Awareness (LoCA 2007)*, ISBN: 978-3-540-75159-5, Volume 4718/2007, pp. 85-102, September 2007. (Best presentation award.)

Ivanov, Y.; Wren, C.; Sorokin, A.; Kaur, I., "Visualizing the History of Living Spaces", *IEEE Transactions on Visualization and Computer Graphics, IEEE Visualization Conference (VIS) and IEEE Information Visualization Conference (INFOVIS) Proceedings 2007*, Vol. 13, Issue 6, pp. 1153-1160, Nov-Dec 2007 (Best paper award.)

Xin, J.; Vetro, A.; Sekiguchi, S.-I., "A Study of MPEG-2 to H.264/AVC Transcoding with Half-Horizontal Resolution", *IEEE International Conference on Consumer Electronics (ICCE)*, Session 1.4: Video Transcoding & QoS, January 2008. (Best paper award.)

Nishiuma, N.; Goto, Y.; Kumazawa, H.; Komaya K.; Nikovski, D., "Travel Time Prediction using Singular Value Decomposition", *Journal of the Society of Instrument and Control Engineers of Japan (SICE)*, Vol 42 Issue 7, July 2006. (Received the SICE best paper award for 2008.)

Technical Staff

The most important assets of MERL are its people. The following pages present the capabilities and interests of MERL's technical staff members as of the end of the period of this report. Additional information about their work can be found in the publications list and the project descriptions in this report. Complete information can be found in people's individual web pages at "<http://www.merl.com/people>".



Amit Agrawal *Ph.D., University of Maryland, 2006*
Research Scientist

Prior to his graduate studies, Agrawal worked as a DSP engineer at Hughes Software Systems, India, for one year. His research interests are in computer vision, image processing and computational photography. Current projects include motion photography, flash photography, surface reconstruction from gradient fields, high dynamic range imaging, and image editing under variable illumination using gradient domain methods.



Ramesh Annavajjala *Ph.D., University of California at San Diego, 2006*
Member Technical Staff

Annavajjala joined MERL in 2008. Prior to that, he was a Systems Research Engineer at ArrayComm LLC, in San Jose, CA., working for the development of advanced interference cancellation algorithms for next generation wireless standards.



Ali Azarbayejani *Ph.D., Massachusetts Institute of Technology, 1997*
Principal Technical Staff

Azarbayejani's thesis was on computer-vision-based computational 3D geometry and underlying nonlinear probabilistic methods. In 1997, he founded Alchemy 3D Technology to develop technology and software based on his research. There, he led the development of new markets in the film and video post-production industry for vision-based software. In 2003, he joined MERL with interests in technology, software, and business development.



Luigi Baccari *B.S., University of Massachusetts of Lowell*
Manager Computational & Network Services

Baccari has 23 years of experience in the System and Network Administrations field. For the 6 years prior to joining MERL he worked at HP/Compaq's Cambridge Research Labs providing System and Network. Previous to that he worked for Force Computers, Lycos and Digital Equipment Corp. as Data Center Manger and in various System/Network Support roles.



John C. Barnwell III
Research Associate

John Barnwell is a former Software Engineer developing configuration and database systems for the aircraft manufacturing, food processing, large truck manufacturing, and computer manufacturing industries. His current personal interests include amateur radio, CNC control systems, and mechanical and electrical design.



Ghulam M. Bhatti *Ph.D., Boston University, 1998*
Principal Technical Staff

For his thesis, Bhatti specialized in distributed and parallel discrete event simulation. Before joining MERL in 2000, he worked as a Sr. Software Engineer at Evare LLC, Inc, developing software for a network switch and implementing an RSA cryptographic scheme. He also worked at Excel Tech. Ltd. (XLTEK) developing embedded software for a portable EEG device. Currently, he is working on Home Networking and Digital TV.



Matthew E. Brand *Ph.D., Northwestern University, 1994*
Senior Research Scientist

Brand studies unsupervised learning from sensory data. His results include spectral solutions for reconstructing manifolds from samples, decision-theoretic elevator group control, a linear-time online SVD, recovery of non-rigid 3D shape from ordinary video, and an entropy optimization framework for learning. He has received best paper awards in computer vision (CVPR2001) and scheduling (ICAPS2003).



Dirk Brinkman *J.D., Suffolk University Law School, 1990*
Patent Counsel

Brinkman's undergraduate and Masters work was in Medical Physics. Prior to joining MERL in 1998, he spent most of his career at Digital Equipment Corporation, first as an engineer and product manager in the Medical Systems Group and then as a Patent Attorney for Digital's Research Laboratories in Cambridge MA and Palo Alto CA.



William J. Butera *Ph.D., Massachusetts Institute of Technology, 2002*
Senior Research Scientist

Previously at Intel, Bill initiated and drove a technology initiative on Scale-free Architecture. Prior to Intel, he worked at the MIT Media Lab's Center for Bits and Atoms, Micronas Semiconductor and Standard Elektrik Lorenz (both in Germany). Bill is working on various projects that have severe computational requirements (e.g., patient alignment for Particle Beam Therapy).



Robert A. Cohen *Ph.D., Rensselaer Polytechnic Institute, 2007*
Principal Technical Staff

Prior to getting his Ph.D., Robert Cohen worked for 11 years at Philips Research Labs in NY on HDTV, scalable video streaming, video surveillance, and rapid prototyping for VLSI video systems. His current research interests are algorithms and architectures for video coding and communications, and video, image and signal processing. He is currently researching video transcoding and next-generation video coding algorithms.



Johnas I. Cukier *M.Sc., Polytechnic Institute of New York, 1985*
Senior Principal Technical Staff

Cukier joined MERL in 1996. His initial focus was on digital systems for CATV, RF microwave transmitters & receivers, and front-ends for advanced TV receivers. His current interests are in advanced Digital Networking and Digital Signal Processing.



Chunjie Duan *Ph.D., University of Colorado at Boulder, 2008*
Principal Technical Staff

Prior to joining MERL, Duan worked for Alcatel, Qualcomm and Ericsson and other telecomm companies for over 10 years. His research interests are in wireless and optical communications, digital signal processing and VLSI/CAD technology. He is currently working on Ultra-Wideband system development and LSI implementation.



Khalid El-Rifai *Ph.D., Massachusetts Institute of Technology, 2007*
Research Scientist

Khalid El-Rifai received his M.S. and Ph.D. degrees from the MIT Department of Mechanical Engineering in 2003 and 2007, respectively. He obtained his B.S. degree in Mechanical Engineering from Purdue University in 2001. His main research interests are adaptive and nonlinear control, hybrid systems and control, and mechatronics and robotics.



Osamah El-Rifai *Ph.D., Massachusetts Institute of Technology, 2002*
Principal Research Scientist

Osamah El-Rifai's Ph.D. thesis topic was the Modeling and Control of Undesirable Dynamics in Atomic Force Microscopes. After graduation he continued at the MIT as a Research Scientist for three years. Prior to joining MERL he was a Senior Precision Systems Engineer at Delta Search Labs, a local start-up, where he led a group of engineers on several projects in instrumentation, controls, and design.



Alan W. Esenther *M.Sc., Boston University, 1993*
Principal Technical Staff

Esenther enjoys human-computer interaction (HCI) design, distributed software development, graphical user interfaces and Internet technologies. His recent work has focused on touch applications that support multiple concurrent users (think multiple mice), rapid image presentation for video browsing, and instant co-browsing (lightweight real-time distributed collaboration using unmodified web browsers).



Clifton L. Forlines *Master of HCI, Carnegie Mellon University, 2001*
Research Scientist

Forlines' research interests include the design and evaluation of novel user interfaces. His current research projects span from three-dimensional presentation of and navigation through recorded digital video, to collaborative tabletop user interfaces, to using hand-held projectors for augmented reality. He is currently leading the user evaluation of three projects, MediaFinder, TimeTunnel, and DiamondSpin.

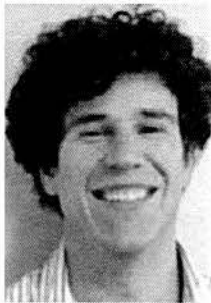

Abraham Goldsmith *M.S., Worcester Polytechnic Institute*
Research Associate

Abraham Goldsmith has five years industry experience as a design Electrical Engineer and holds a master in Electrical Engineering from Worcester Polytechnic Institute. He's also very good at mechanical design and is a "shop demon".

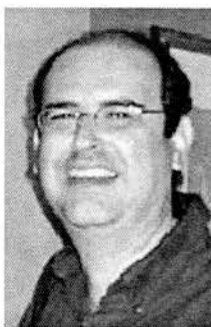

Evandro Gouvêa *Ph.D., Carnegie Mellon University, 1999*
Principal Technical Staff

Previously at CMU, Dr. Evandro Gouvea was involved in the design and development of Sphinx-4—a Java platform speech recognition system. He was also part of Project LISTEN, which uses speech recognition to help elementary school-aged children learn how to read. Prior to CMU, he worked at Vocollect, Inc., where he built the speech recognition system used in their core products wearable computer for warehouses.



Jianlin Guo *Ph.D., Windsor University, 1995*
Principal Technical Staff

Guo worked at Waterloo Maple for a year and a half as a software developer before joining MERL in 1998. His primary research interests include home networks, digital broadcasting, and wireless computing.



Bret A. Harsham *Massachusetts Institute of Technology*
Principal Technical Staff

Harsham joined MERL in 2001 to pursue interests in speech interfaces and speech-centric devices. Previously, Bret spent 3 1/2 years at Dragon Systems designing and implementing handheld and automotive speech products. Earlier, he was a principal architect of a Firewall and Virtual Private Network product. Harsham's other technical interests include distributed architectures, knowledge representation, and language theory.



Frederick J. Igo, Jr. *B.A., LeMoyne College, 1982*
Senior Principal Technical Staff

Igo's professional interests are in software development and its process. He joined MERL in 1985 and has worked on various software technologies, including Distributed Computing, Distributed OLTP, Message Queuing, Mobile Agents, OLAP/MDDDB and Data Mining. Prior to joining MERL Fred worked at IPL systems.



Yuri A. Ivanov *Ph.D., Massachusetts Institute of Technology, 2001*
Principal Technical Staff

Ivanov's main research interests lie in the area of Computer Vision, Machine Learning and Data Mining. In particular, he is interested in dynamic observations - video sequences, sounds, gestures, actions and events.



Ankur Jain *Ph.D., University of California, Santa Barbara, 2006*
Member Technical Staff

Ankur Jain's doctoral thesis explores the aspects of efficient machine learning and data mining techniques for evolving data such as data streams. As a member of the Analytics team at MERL, his work has been focused on developing incremental machine learning techniques for sensor data analysis.



Michael J. Jones *Ph.D., Massachusetts Institute of Technology, 1997*
Senior Principal Technical Staff

Jones joined MERL in 2001 after 4 years at the Digital/Compaq Cambridge Research Laboratory. His main area of interest is computer vision. He is particularly interested in using machine-learning approaches for solving computer vision problems. He has focused on algorithms for detecting and analyzing people in images and video such as face detection, skin detection and facial analysis using morphable models.



Keisuke Kojima *Ph.D., University of Tokyo, 1990*
Senior Research Scientist / Senior Liaison

Kojima spent 8 years in Melco's Central research lab and 9 years at AT&T Bell Labs. He has been involved in the research and development of semiconductor lasers, optical communication modules, and optical communication and sensor systems. At MERL, he is engaged in the research of security systems and sensor technologies.



Jonathan Leonard *B.S., Northeastern University, 2008*
IP Systems Administrator

Jon works in the Central Services Department at MERL. He previously worked at MIT Lincoln Laboratory and graduated from Northeastern University. While not at work, he enjoys marital arts and regularly competes in competitions.



Amine Maaref *Ph.D., University of Quebec, 2007*
Visiting Research Scientist

Amine is helping us to develop a 3GPP LTE system simulator to perform system analysis for various schemes such as virtual MIMO, inter-cell interference management, beam forming and MIMO interference management. His expertise is in the area of very high configuration MIMO wireless systems. Before joining MERL, Amine was an NSERC postdoctoral research fellow with the University of British Columbia.



Janet McAndless
Technical Associate

McAndless formerly held a variety of tech-related positions including management of peer review processes, web development, film and television post production, technical writing/documentation, and technical-support. For many years she has been involved with the planning of the annual SIGGRAPH conferences.



Andreas F. Molisch *Ph.D., Technical University Vienna, 1994*
Distinguish Member Technical Staff

Andy Molisch's current research interests are multiple-antenna systems, wireless channel measurement and modeling, ultra wideband systems, sensor networks, and OFDM. He has authored or co-authored four books some 100-journal papers, and numerous conference papers. He is a Fellow of IEEE and a Fellow of the IET.



Clifton D. Mueller *J.D., Boston College Law School, 2005*
Patent Attorney

Clifton Mueller received his Bachelor of Science degree from M.I.T. in 1997 with a major in Chemistry and minors in Biology and Music Composition. Prior to starting law school in 2002, he was a research associate at PRAECIS Pharmaceuticals, Inc. in Cambridge, MA working on therapies for Alzheimer's disease, rheumatoid arthritis and HIV.



Barton Nicholls *Northeastern University*
Systems & Network Administrator

Nicholls is a member of MERL's Computer Network Services Group. He supports primarily UNIX and some Windows client and infrastructure software and hardware, and networking services for MERL. He comes to us from Verizon's Network Operations Management Group, and before that Information Technology at Art Technology Group.



Daniel N. Nikovski *Ph.D., Carnegie Mellon University, 2002*
Team Leader Analytics Group

Nikovski's research is focused on algorithms for reasoning, planning, and learning with probabilistic models. His current work is on the application of such algorithms to hard transportation problems such as group elevator control and traffic prediction. He also has varied interests in the field of data mining.



Philip V. Orlik *Ph.D., State University of New York at Stony Brook, 1999*
Principal Technical Staff

Orlik joined MERL's digital communications and networking group in 2000. His research interests include wireless and optical communications, networking, queuing theory, and analytical modeling.



Ronald N. Perry *B.Sc., Bucknell University, 1981*
Distinguished Research Scientist

Prior to joining MERL in 1998, Perry was a consulting engineer at DEC developing a three-dimensional rendering ASIC called Neon. Ron has consulted for many companies including Kodak, Adobe, Quark, and Apple over the last 20 years, developing software and hardware products in the areas of computer graphics, imaging, color, and desktop publishing. Ron's research interests are centered on key algorithms in computer graphics.



Fatih M. Porikli *Ph.D., Polytechnic University, 2002*
Senior Principal Technical Staff

Porikli's research interests are in the areas of video processing, computer vision, aerial image processing, 3-D depth estimation, texture segmentation, robust optimization, network traffic management, multi-camera systems, data mining, and digital signal filtering. Before joining MERL in 2000, he worked for Hughes Research Labs, Malibu, CA (1999) and AT&T Research Labs, Holmdel, NJ (1997).



Bhiksha Raj *Ph.D., Carnegie Mellon University, 2000*
Principal Research Scientist

Raj works mainly on algorithmic aspects of speech recognition, with special emphasis on improving the robustness of speech recognition systems to environmental noise. His latest work is on the use of statistical information about speech for the automatic design of filter-and-sum microphone arrays. Prior to joining MERL, Raj worked at Compaq's Cambridge MA lab.



Shantanu Rane *Ph.D., Stanford University, 2007*
Research Scientist

Shantanu Rane's Ph.D. thesis applied distributed source coding concepts to error-resilient video transmission. Shantanu's research interests are in the areas of image communication and information theory. At MERL, he is working on problems involving distributed compression of images and video.



Zafer Sahinoglu *Ph.D., New Jersey Institute of Technology, 2001*
Principal Technical Staff

Sahinoglu worked at AT&T Shannon Labs in 1999, and joined MERL in March 2001. His research interests include home networking, QoS in video streaming and multicasting, wireless image sensor networks, traffic self-similarity and biomedical signal processing. He has made significant contributions to the emerging MPEG-21 and ZigBee standards.



Masashi Saito *Ph.D., Osaka University, 2006*
Senior Principal Technical Staff

Masashi Saito received his Ph.D. in Computer Science specializing in Distributed Systems. Before joining MERL in 2006, he worked as a Senior Software Engineer at MELCO's Information Technology R&D Center doing research on operating systems, Internet protocols and distributed systems. His interests include wireless networking, algorithms, software development and Internet services.



Bent K. Schmidt-Nielsen *B.S. Univ. of California at San Diego, 1971*
Team Leader Speech Group

Schmidt-Nielsen spent 7 years at Dragon Systems applying speech recognition to useful products. At MERL he is paying a lot of attention to making speech interfaces robust and usable. He has very broad interests in science and technology. Among many other activities he has taught genetics at the University of Massachusetts at Boston and he has been a leader in the development of an easy to use mass-market database.



Derek L. Schwenke *M.S., Worcester Polytechnic Institute, 1988*
Principal Technical Staff

Before joining MERL in 1988, Schwenke worked at Raytheon on image processing and satellite communications systems. At MERL he worked on the design and simulation of CPU hardware and a wide range of software development projects including multi-user virtual reality, mobile agents on the Internet, and multi-modal interfaces. He is an active member of the W3C VoiceXML and Multimodal working groups.



Kuntal Sengupta *Ph.D., Ohio State University, 1996*
Principal Technical Staff

Before joining MERL in 2006, Sengupta worked at AuthenTec, a leading fingerprint sensor company on the design and implementation of indexing, image reconstruction, navigation, template compression and anti-spoofing functionalities. His software implementations made it in to several million cell phones and PCs that AuthenTec shipped.



Samuel E. Shipman *M.Sc., Carnegie Mellon University, 1985*
Principal Technical Staff

Shipman's interests include real-time analysis of video and audio content, and real-time and distributed operating systems. He has worked on the Video Summarization, TimeTunnel, DiamondTouch, Open Community, and Network Replication projects, and on smaller efforts related to fingerprint recognition, MPEG-7, and interactive surroundings.



Alan Sullivan *Ph.D., University of California at Berkeley, 1993*
Senior Research Scientist

Prior to joining MERL, Alan Sullivan worked on developing and commercializing the DepthCube volumetric 3D display technology, (The DepthCube is a DLP-based rear-projection multiplanar display that produces physically deep 3D images.) He has 8 issued patents and 15 patents pending in the fields of display technology, computer graphics, material science and optics.



Zhifeng (Jeffrey) Tao *Ph.D., Polytechnic University, 2006*
Member Technical Staff

Zhifeng Tao joined MERL in September 2006. His research interests include wireless networking, medium access control, quality of service, cooperative communications and analytical modeling. He has been an active participant in IEEE 802.11n and 802.11s standardization since 2004, and is currently involved in developing the IEEE 802.16j and 802.16m.



Koon Hoo Teo *Ph.D., University of Alberta 1990*
Team Leader Mobile Systems Group

Teo was with Nortel for about 15 years where he was actively involved in the research and implementation issues of a number of 3G and 4G wireless systems including Wireless Mesh Networks and WiMAX systems. His current research interests include Cognitive Radio, location tracking using Ultra Wideband technology, and Wireless Mesh and Multi-Hop Systems.



Jay E. Thornton *Ph.D., University of Michigan, 1982*
Group Manager Imaging

Thornton worked at Polaroid Corporation for many years, first in the Vision Research Laboratory and then as manager of the Image Science Laboratory. There, he worked on problems in color reproduction, image quality and image processing. He joined MERL in 2002 as Manager of the Computer Human Observation project, focusing on the computer vision problems that arise when computers analyze, measure, count, detect, and recognize people.



Anthony Vetro *Ph.D., Polytechnic University, 2001*
Group Manager Multimedia

Vetro joined MERL in 1996. His research interests are related to the encoding and transport of multimedia content. He has been an active participant in MPEG standards for several years. Dr. Vetro has contributed several technologies to MELCO products, including MPEG-2/4 transcoding for surveillance, post-filtering for artifact reduction and video down-decoding for a low-cost DTV receiver chip.



Gene V. Vinokur *M.S., Boston University, 2003*
Associate Patent Agent

Prior to joining MERL, Vinokur spent four years at Putnam Investments developing software applications for the financial industry. He has been a licensed Patent Agent since 2003. He joined MERL's Patent Department in 2006.



Garrett Weinberg *B.A., Yale University, 2000*
Member Technical Staff

Before coming to MERL, Weinberg designed and internationalized automotive speech user interfaces at Dragon Systems, and was a chief architect and implementer of enterprise solutions for two Boston-area startups specializing, respectively, in Digital Rights Management and portfolio management. At MERL, he is leading the effort to port SpokenQuery technologies to various mobile and embedded platforms.



Kevin W. Wilson *Ph.D., Massachusetts Institute of Technology, 2006*
Member Technical Staff

For his doctoral thesis, Kevin Wilson incorporated aspects of the psychoacoustics of the precedence effect into an algorithm for computerized audio source localization. He is currently working on applications of signal processing and machine learning to audio processing, video processing and equipment condition monitoring.



Christopher R. Wren *Ph.D., Massachusetts Institute of Technology, 2000*
Principal Research Scientist

Wren's research area is Perception for Human-Computer Interaction. While his recent work has focused on using computer vision techniques to create systems that are visually aware of the user, his current interests also extend to include audio processing and other sensing modalities. As part of his thesis work at MIT, he developed a system for combining physical models with visual evidence in real time to recover subtle models of human motion.



Sehoon Yea *Ph.D., Rensselaer Polytechnic Institute, 2006*
Member Technical Staff

From 1996 to 2001, Yea was a Research Engineer at the Institute for Advanced Engineering in Korea, working on control systems such as industrial robots and servo-drivers. In the summer of 2004, he was an Intern with Sarnoff Corporation. Since joining MERL his work has focused on digital image and video compression, enhancement and communication.



Jonathan S. Yedidia *Ph.D., Princeton University, 1990*
Senior Research Scientist

Yedidia's graduate work focused on theoretical condensed-matter physics, particularly the statistical mechanics of systems with quenched disorder. In 1997, he changed his focus to computer software and worked for a company called Viaweb on a shopping search engine, which has since become Yahoo's shopping service. At MERL since 1998, his particular interest is in the development of new methods belief propagation in constraint networks.



William S. Yerazunis *Ph.D., Rensselaer Polytechnic Institute, 1987*
Senior Research Scientist / Team Leader Hardware

Yerazunis has worked in a number of fields including: optics, vision processing, and signal processing, computer graphics, artificial intelligence parallel symbolic computation, radio astronomy and SETI, transplant immunology, virtual and augmented reality (Diamond Park and SPLINE), real-time sensing and ubiquitous computing, and real-time statistical categorization of text (for spam filtering).



Raymond Yim *Ph.D., Harvard University, 2006*
Research Scientist

Raymond has conducted successful research on the design and analysis of cross-layered architectures and protocols for wireless communication networks including cellular systems, wireless LANs, and sensor networks.



Jinyun Zhang *Ph.D., University of Ottawa, 1991*
Group Manager Digital Communication

Zhang manages MTL's digital communication and networking group. Before joining MERL in 2001, She worked for Nortel Networks for 10 years where she held engineering and management positions in the areas of VLSI design, advanced wireless technology development and wireless & optical networks. She has a broad technical background, specializing in system design and real-time embedded software for wireless communications.

Recent Major Publications

The following lists the 116 major publications by members of the MERL staff over the past year. (This is an average of more than 2 papers per technical staff member). A publication is considered major if it appeared in a refereed journal, a refereed conference proceeding or some other significant publication such as a book.

An asterisk (*) appears before the 31 publications (27%) that were subject to highly stringent selection criteria where they were published. Some venues (such as major journals and certain key conferences) are very selective in what they publish and some (such as workshops and many conferences) are not. There are good reasons to publish something in a non-selective venue, the most important of which being that a given workshop or conference may be the best place at which to expose a particular piece of work to the scientific community. However, the mere appearance of a piece of work in a non-selective venue says little if anything about the quality of the work in the eyes of the scientific community.

As a basis for assessing the selectivity of various venues, the list below uses acceptance rates. For instance, certain key conferences such as CVPR and SIGGRAPH accept only 20% or less of the papers submitted to them, rejecting many papers that in fact describe fine work. In contrast, many workshops and regional conferences accept 80% or more of the papers submitted. The list below puts an asterisk before a conference or workshop paper only if the acceptance rate was less than 25% or the paper received a best paper award. In addition, asterisks appear before papers in major archival journals.

- * Veeraraghaven, A.; Agrawal, A.; Raskar, R.; Mohan, A.; Tumblin, J., "Non-Refraction Modulators for Encoding and Capturing Scene Appearance and Depth", *IEEE Computer Society Conference on Computer Vision and Pattern Recognition (CVPR)*, June 2008 (TR2008-028)
- * Sutcu, Y.; Rane, S.; Yedidia, J.S.; Draper, S.C.; Vetro, A., "Feature Transformation of Biometric Templates for Secure Biometric Systems based on Error Correcting Codes", *IEEE Computer Society Conference on Computer Vision and Pattern Recognition (CVPR)*, June 2008 (TR2008-029)
- * Porikli, F., "Constant Time O(1) Bilateral Filtering ", *IEEE Computer Society Conference on Computer Vision and Pattern Recognition (CVPR)*, June 2008 (TR2008-030)
- * Tuzel, O.; Porikli, F.; Meer, P., "Learning on Lie Groups for Invariant Detection and Tracking", *IEEE Computer Society Conference on Computer Vision and Pattern Recognition (CVPR)*, June 2008 (TR2008-031)
- * Hussein, M.; Porikli, F.; Davis, L., "Kernel Integral Images: A Framework for Fast non-Uniform Filtering", *IEEE Conference on Computer Vision and Pattern Recognition (CVPR)*, ISSN: 1063-6919, June 2008 (TR2008-033)

- * Mohan, A.; Huang, X.; Tumblin, J., Raskar, R., "Sensing Increased Image Resolution Using Aperture Masks", *IEEE Conference on Computer Vision and Pattern Recognition (CVPR)*, ISSN: 1063-6919, June 2008 (TR2008-065)
- * Parag, T.; Porikli, F.; Elgammal, A., "Boosting Adaptive Linear Weak Classifiers for Online Learning and Tracking", *IEEE Conference on Computer Vision and Pattern Recognition (CVPR)*, ISSN: 1063-6919, June 2008 (TR2008-065)
- * Brand, M.; Pletscher, P., "A Conditional Random Field for Automatic Photo Editing", *IEEE Conference on Computer Vision and Pattern Recognition (CVPR)*, ISSN: 1063-6919, June 2008 (TR2008-035)

Nikovski, D., "Workflow Trees for Representation and Mining of Implicitly Concurrent Business Processes", *International Conference on Enterprise Information Systems (ICEIS)*, June 2008 (TR2008-034)

Duan, C.; Zhu, C.; Khatri, S.P., "Forbidden Transition Free Crosstalk Avoidance CODEC Design", *ACM/IEEE Design Automation Conference*, ISSN: 0738-100X, pp. 986-991, June 2008 (TR2008-023)

Forlines, C.; Lilien, R., "Adapting a Single-user, Single-display Molecular Visualization Application for Use in a Multi-user, Multi-Display Environment", *Advanced Visual Interfaces (AVI)*, Poster Session, ISBN 0-078-60558-141-5, pp. 367-371, May 2008 (TR2008-019)

Matusik, W.; Forlines, C.; Pfister, H., "Multiview User Interfaces with an Automultiscopic Display", *Advanced Visual Interfaces*, Poster Session, ISBN 0-978-60558-141-5, pp. 363-366, May 2008 (TR2008-018)

Forlines, C., "Content Aware Video Presentation on High-Resolution Displays", *Advanced Visual Interfaces (AVI)*, ISBN 0-978-60558-141-5, pp. 57-64, May 2008 (TR2008-020)

Wittenburg, K.; Lanning, T.; Leigh, D.; Ryall, K., "Visualizing Antenna Design Spaces", *International Working Conference on Advanced Visual Interfaces (AVI)*, ISBN: 0-978-60558-141-5, pp. 83-90, May 2008 (TR2008-017)

Yea, S.; Vetro, A., "View Synthesis Prediction for Rate-Overhead Reduction in FTV", *3DTV-Conference*, ISBN: 978-1-4244-1670-5, pp. 145-148, May 2008 (TR2008-016)

Brandl, P.; Forlines, C.; Wigdor, D.; Haller, M.; Shen, C., "Combining and Measuring the Benefits of Bimanual Pen and Direct-Touch Interaction of Interfaces", *International Working Conference on Advanced Visual Interfaces (AVI)*, ISBN: 0-978-60558-141-5, May 2008 (TR2008-054)

Draper, S.C.; Liu, A.; Molisch, A.F.; Yedidia, J.S., "Routing in Cooperative Wireless Networks with Mutual-Information Accumulation", *IEEE International Conference on Communications (ICC)*, ISBN: 978-1-4244-2075-9, pp. 4272-4277, May 2008 (TR2008-021)

Ozdemir, O.; Sahinoglu, Z.; Zhang, J., "Narrowband Interference Resilient Receiver Design for Unknown UWB Signal Detection", *IEEE International Conference on Communications (ICC)*, ISBN: 978-1-4244-2075-9, pp. 785-789, May 2008 (TR2008-022)

Gezici, S.; Guvenc, I.; Sahinoglu, Z., "On the Performance of Linear Least-Squares Estimation in Wireless Positioning Systems", *IEEE International Conference on Communications (ICC)*, ISBN: 978-1-4244-2075-9, pp. 4203-4208, May 2008 (TR2008-025)

Ergut, S.; Rao, R.R.; Dural, O.; Sahinoglu, Z., "Localization via TDOA in a UWB Sensor Network using Neural Networks", *IEEE International Conference on Communications (ICC)*, ISBN: 978-1-4244-2075-9, pp. 2398-2403, May 2008 (TR2008-024)

Ye, Z.; Duan, C.; Orlik, P.; Zhang, J., "A Low-Complexity Synchronization Design for MB-OFDM Ultra-Wideband Systems", *IEEE International Conference on Communications (ICC)*, ISBN: 978-1-4244-2075-9, pp. 3807-3813, May 2008 (TR2008-032)

Yim, R.; Mehta, N.B.; Molisch, A.F., "Best Node Selection through Distributed Fast Variable Power Multiple Access", *IEEE International Conference on Communications (ICC)*, ISBN: 978-1-4244-2075-9, pp. 5028-5032, May 2008 (TR2008-049)

Nie, C.; Tao, Z.; Mehta, N.B.; Molisch, A.F.; Zhang, J.; Kuze, T.; Panwar, S., "Antenna Selection for Next Generation IEEE 802.16 Mobile Stations", *IEEE International Conference on Communications (ICC)*, ISBN: 978-1-4244-2075-9, pp. 3457-3462, May 2008 (TR2008-050)

Chen, Y.; Teo, K.H.; Kishore, S.; Zhang, J., "A Game-Theoretic Framework for Interference Management through Cognitive Sensing", *IEEE International Conference on Communications (ICC)*, ISBN: 978-1-4244-2075-9, pp. 3573-3577, May 2008 (TR2008-060)

Chen, Y.; Teo, K.H.; Kishore, S.; Zhang, J., "Inter-Cell Interference Management in WiMAX Downlinks by a Stackelberg Game between BS", *IEEE International Conference on Communications (ICC)*, ISBN: 978-1-4244-2075-9, pp. 3442-3446, May 2008 (TR2008-059)

Hussein, M.; Porikli, F.; Davis, L., "Towards Practical Evaluation of Pedestrian Detectors", *IEEE Workshop on Human Detection from Mobile Platforms*, May 2008 (TR2008-088)

Lou, J.; Liu, S.; Vetro, A.; Sun, M-T, "Complexity and Memory Efficient GOP Structures Supporting VCR Functionalities in H.264/AVC", *IEEE International Symposium on Circuits and Systems (ISCAS)*, ISBN: 978-1-4244-1683-7, pp. 636-639, May 2008 (TR2008-041)

- * Wyne, S.; Molisch, A.F.; Almers, P.; Eriksson, G.; Karedal, J.; Tufvesson, F., "Outdoor-to-Indoor Office MIMO Measurements and Analysis at 5.2 GHz", *IEEE Transactions On Vehicular Technology*, ISSN: 0018-9545, Vol. 57, Issue 3, pp. 1374-1386, May 2008 (TR2008-048)

Harrysson, F.; Medbo, J.; Molisch, A.F.; Johansson, A.J.; Tufvesson, F., "The Composite Channel Method: Efficient Experimental Evaluation of a Realistic MIMO Terminal in the Presence of a Human Body", *IEEE Vehicular Technology Conference (VTC)*, ISSN: 1550-2252, pp. 473-477, May 2008 (TR2008-047)

Santos, T.; Karedal, J.; Almers, P.; Tufvesson, F.; Molisch, A.F., "Scatterer Detection by Successive Cancellation for UWB - Method and Experimental Verification", *IEEE Vehicular Technology Conference (VTC)*, ISSN: 1550-2252, pp. 445-449, May 2008 (TR2008-046)

Gezici, S.; Sahinoglu, Z.; Molisch, A.F.; Kobayashi, H.; Poor, H.V., "Two-Step Time of Arrival Estimation for Pulse-Based Ultra-Wideband Systems", *EURASIP Journal on Advances in Signal Processing*, Vol. 2008, Article ID 529134, 11 pages, doi:10.1155/2008/529134, April 2008

Forlines, C.; Balakrishnan, R., "Evaluating Tactile Feedback and Direct vs. Indirect Stylus Input in Pointing and Crossing Selection Tasks", *ACM Conference on Human Factors in Computing Systems (CHI)*, ISBN: 978-1-60558-011-1, pp.15631572, April 2008 (TR2008-039)

Jiang, H.; Wigdor, D.; Forlines, C.; Borkin, M.; Kauffmann, J.; Shen, C., "LivOlay: Interactive Ad-hoc Registration and Overlapping of Applications for Collaborative Visual Exploration", *ACM Conference on Human Factors in Computing Systems (CHI)*, ISBN: 978-1-60558-011-1, pp. 1357-1360, April 2008 (TR2008-040)

Mei, X.; Porikli, F., "Joint Tracking and Video Registration by Factorial Hidden Markov Models", *International Conference on Acoustic Speech and Signal Processing (ICASSP)*, ISSN: 1520-6149, pp. 973-976, March 2008 (TR2008-010)

Li, Y.; Zhang, J., "Hot-Spot Wireless Access Exploiting Shadowing Diversity of Distributed Antennas", *IEEE International Symposium on Broadband Multimedia Systems and Broadcasting (BMSB)*, ISBN: 978-1-4244-1648-6, pp. 1-5, March 2008 (TR2008-051)

Yim, R.; Mehta, N.B.; Molisch, A.F.; Zhang, J., "MAC 24-1 Efficient Multiple Access using Received Signal Strength and Local Channel Information", *IEEE Wireless Communications and Networking Conference (WCNC)*, ISSN: 1525-3511, pp. 1962-1967, March 2008 (TR2008-045)

Tao, Z.; Li, A.; Zhang, J.; Kuze, T., "MAC 25-4 - Performance Improvement for Multichannel HARQ Protocol in Next Generation WiMAX System", *IEEE Wireless Communications and Networking Conference (WCNC)*, ISSN: 1525-3511, pp. 2009-2014, March 2008 (TR2008-053)

Smaragdis, P.; Raj, B.; Shashanka, M., "Sparse and Shift-Invariant Feature Extraction from Non-Negative Data", *IEEE International Conference on Acoustics, Speech and Signal Processing (ICASSP)*, ISSN: 1520-6149, pp. 2069-2072, March 2008 (TR2008-013)

Wilson, K.W.; Raj, B.; Smaragdis, P.; Divakaran, A., "Speech Denoising Using Nonnegative Matrix Factorization with Priors", *IEEE International Conference on Acoustics, Speech and Signal Processing (ICASSP)*, ISSN: 1520-6149, pp. 4029-4032, March 2008 (TR2008-012)

Kalgaonkar, K.; Raj, B., "Ultrasonic Doppler Sensor for Speaker Recognition", *IEEE International Conference on Acoustics, Speech and Signal Processing (ICASSP)*, ISSN: 1520-6149, pp. 4865-4868, March 2008 (TR2008-014)

Draper, S.; Liu, L.; Molisch, A.; Yedidia, J., "Iterative Linear-Programming-Based Route Optimization for Cooperative Networks", *IEEE International Zurich Seminar on Communications*, ISBN: 978-1-4244-1682-0, pp. 84-87, March 2008 (TR2008-009)

Duan, C.; Khatri, S.P., "Energy Efficient and High Speed On-Chip Ternary Bus", *Design, Automation and Test in Europe*, ISBN: 978-3-9810801-4-8, pp. 515-518, March 2008 (TR2008-015)

Gezici, S.; Sahinoglu, Z., "Ranging in a Single-Input Multiple Output (SIMO) System", *IEEE Communications Letters*, ISSN: 1089-7798, Vol. 12, Issue 3, pp. 197-199, March 2008 (TR2008-055)

Paier, A.; Zemen, T.; Bernado, I.; Matz, G.; Karedal, J.; Czink, N.; Dumard, C.; Tufvesson, F.; Molisch, A.F.; Mecklenbrauker, C.F., "Non-WSSUS Vehicular Channel Characterization in Highway and Urban Scenarios at 5.2 GHz Using the Local Scattering Function", *International ITG Workshop on Smart Antennas (WSA)*, ISBN: 978-1-4244-1756-8, pp. 9-15, February 2008 (TR2008-044)

Schmidt-Nielsen, B.; Harsham, B.; Raj, B.; Forlines, C., "Speech-Based UI Design for the Automobile", *Handbook of Research on User Interface Design and Evaluation for Mobile Technology*, ISBN: 978-1-59904-871-0, Vol. 1, Chapter XV, pp. 237-252, February 2008 (TR2008-006)

Schwenke, D.; Vetro, A.; Hata, T, "Server-Driven Progressive Image Transmission of JPEG 2000", *SPIE Conference on Visual Communications and Image Processing (VCIP)*, Vol. 6822, January 2008 (TR2008-005)

Vo, D.T.; Yea, S.; Vetro, A., "Spatio-Temporal Fuzzy Filtering for Coding Artifacts Reduction", *SPIE Conference on Visual Communications and Image Processing (VCIP)*, Vol. 6822, January 2008 (TR2007-077)

Liu, S.; Kim, W-S.; Vetro, A., "Bit-depth Scalable Coding for High Dynamic Range Video", *SPIE Conference on Visual Communications and Image Processing (VCIP)*, Vol. 6822, January 2008 (TR2007-078)

Porikli, F., "Reshuffling: A Fast Algorithm for Filtering with Arbitrary Kernels", *SPIE Electronic Imaging Conference on Real-Time Image Processing*, Vol. 6811, January 2008 (TR2008-007)

Glazunov, A.A.; Molisch, A.F.; Tufvesson, F., "Fading Characterization in a Semi-Anechoic Chamber with Artificial Scatterers for Mean Effective Gain Measurements of Wireless Handheld Terminals", *IEEE radio and Wireless Symposium*, ISBN: 978-1-4244-1463-5, pp. 611-614, January 2008 (TR2008-043)

Dagtas, S.; Pekhteryev, G.; Sahinoglu, Z.; Can, H.; Challa, N., "Real-Time and Secure Wireless Health Monitoring", *International Journal of Telemedicine and Applications*, ISSN: 1687-6415, Vol. 2008, Issue 4, Article 1, January 2008 (TR2008-026)

- * Zhang, H.; Mehta, N.B.; Molisch, A.F.; Zhang, J.; Dai, H., "Asynchronous Interference Mitigation in Cooperative Base Station Systems", *IEEE Transactions on Wireless Communications*, ISSN: 1536-1276, Vol. 7, Issue 1, pp. 155-165, January 2008 (TR2008-042)
- * Vannucci, G.; Bletsas, A.; Leigh, D., "A Software-Defined Radio System for Backscatter Sensor Networks", *IEEE Transactions on Wireless Communications*, ISSN: 1536-1276, Vol. 7, Issue 6, pp. 2170-2179, June 2008 (TR2008-056)

Minegishi, N.; Sato, H.; Vetro, A.; Izuhara, F.; Koyama, M., "A Multi-Standards HDTV Video Decoder for Blu-Ray Disc Standard", *IEEE International Conference on Consumer Electronics (ICCE)*, Session 6.4: Advanced Video Decoders, January 2008 (TR2008-004)

Yin, Z.; Porikli, F.; Collins, R., "Likelihood Map Fusion for Visual Object Tracking", *IEEE Workshop on Applications of Computer Vision (WACV)*, January 2008 (TR2008-008)

Sengupta, K.; Burman, P., "A Non Parametric Approach for Modeling Interferometric SAR Imagery and Applications", *IEEE Workshop on Applications of Computer Vision (WACV)*, ISSN: 1550-5790, pp. 1-6, January 2008 (TR2008-052)

Xin, J.; Vetro, A.; Sekiguchi, S.-I.; "A Study of MPEG-2 to H.264/AVC Transcoding with Half-Horizontal Resolution", *IEEE International Conference on Consumer Electronics (ICCE)*, Session 1.4: Video Transcoding & QoS, January 2008 (TR2008-003)

Vishvakarma, S.K.; Raj, B.; Singh, R.; Panda, C.R.; Saxena, A.K.; Sasgupta, S., "Analytical Modeling of Threshold Voltage for Nanoscale Symmetric Double Gate (SDG) MOSFET with Ultra Thin Body (UTB)", *International Workshop on Physics of Semiconductor Devices, (IWPSD)*, ISBN: 978-1-4244-1728-5, pp. 277-280, December 2007 (TR2007-108)

Teo, K.H.; Tao, Z.; Zhang, J.; Li, A., "Adaptive Frame Structure for Mobile Multihop Relay (MMR) Networks", *International Conference on Information, Communication & Signal Processing (ICICS)*, ISBN: 978-1-4244-0983-9, pp. 1-5, December 2007 (TR2007-119)

Mehta, N.B.; Molisch, A.F.; Zhang, J.; Bala, E., "Antenna Selection Training in MIMO-OFDM/OFDMA Cellular Systems", *IEEE International Workshop on Computational Advances in Multi-Sensor Adaptive Processing (CAMPSP)*, ISBN: 978-1-4244-1713-1, pp. 113-116, December 2007 (TR2007-094)

Wyne, S.; Santos, T.; Tufvesson, F.; Molisch, A.F., "Channel Measurements of an Indoor Office Scenario for Wireless sensor Applications", *IEEE Global Telecommunications Conference (GLOBECOM)*, ISBN: 978-1-4244-1043-9, pp. 3831-3836, November 2007 (TR2007-092)

Devroye, N.; Mehta, N.B.; Molisch, A. F., "Asymmetric Cooperation Among Relays with Linear Precoding", *IEEE Global Telecommunications Conference (GLOBECOM)*, ISBN: 978-1-4244-1043-9, pp. 4391-4396, November 2007 (TR2007-091)

Liu, H.; Molisch, A.F.; Zhao, S.; Goeckel, D.; Orlik, P., "Hybrid Coherent and Frequency-Shifted-Reference Ultrawideband Radio", *IEEE Global Telecommunications Conference (GLOBECOM)*, ISBN: 978-1-4244-1043-9, pp. 4106-4111, November 2007 (TR2007-093)

Tao, Z.; Li, A.; Teo, K.H.; Zhang, J., "Frame Structure Design for IEEE 802.16j Mobile Multihop Relay (MMR) Networks", *IEEE Global Telecommunications Conference (GLOBECOM)*, ISBN: 978-1-4244-1043-9, pp. 4301-4306, November 2007 (TR2007-120)

Wigdor, D.; Ivanov, Y.; Wren, C.R., "Soda Pop Zombies: Soft Drink Consumption and Motion", *Workshop on Massive Datasets (MD)*, ISBN: 978-1-59593-871-8, pp. 8-9, November 2007 (TR2007-081)

Wren, C.R.; Ivanov, Y.A.; Leigh, D.; Westhues, J., "The MERL Motion Detector Dataset", *Workshop on Massive Datasets (MD)*, ISBN: 978-1-50593-981-8, pp. 10-14, November 2007 (TR2007-069)

- Jain, A.K.; Chellappa, R.; Draper, S.C.; Memon, N.; Phillips, P.J.; Vetro, A., "Signal Processing for Biometric Systems (DSP Forum)", *IEEE Signal Processing Magazine*, ISSN: 1053-5888, Vol. 24, Issue 6, pp. 146-152, November 2007 (TR2007-071)
- * Molisch, A.F.; Mehta, N.B.; Yedidia, J.S.; Zhang, J., "Performance of Fountain Codes in Collaborative Relay Networks", *IEEE Transactions on Wireless Communications*, ISSN: 1536-1276, Vol. 6, Issue 11, pp. 4108-4119, November 2007 (TR2007-082)
- Zwicker, M.; Yea, S.; Vetro, A.; Forlines, C.; Matusik, W.; Pfister, H., "Multi-view Video Compression for 3D Displays", *Asilomar Conference on Signals, Systems and Computers (ACSSC)*, ISSN: 1058-6393, pp. 1506-1510, November 2007 (TR2007-080)
- Xin, J.; Li, J.; Vetro, A.; Sun, H.; Sekiguchi, S., "Motion Mapping for MPEG-2 to H.264/AVC Transcoding", *Multimedia Tools and Applications*, November 2007 (TR2007-004)
- Zwicker, M.; Vetro, A.; Yea, S.; Matusik, W.; Pfister, H.; Durand, F., "Resampling, Antialiasing, and Compression in Multiview 3-D Displays", *IEEE Signal Processing Magazine*, ISSN: 1053-5888, Vol. 24, Issue 6, pp. 88-96, November, 2007 (TR2007-084)
- * Ivanov, Y.; Wren, C.; Sorokin, A.; Kaur, I., "Visualizing the History of Living Spaces", *IEEE Transactions on Visualization and Computer Graphics, IEEE Visualization Conference (VIS) and IEEE Information Visualization Conference (INFOVIS) Proceedings 2007*, ISSN: 1077-2626, Vol. 13, Issue 6, pp. 1153-1160, Nov-Dec 2007 (TR2007-068)
- Smaragdis, P.; Raj, B., "Example-Driven Bandwidth Expansion", *IEEE Workshop on Applications of Signal Processing to Audio and Acoustics*, ISBN: 978-1-4244-1620-2, pp. 135-138, October 2007 (TR2007-089)
- Paier, A.; Karedal, J.; Czink, N.; Hofstetter, H.; Dumard, C.; Zemen, T.; Tufvesson, F.; Molisch, A.F.; Mecklenbrauker, C.F., "Car-to-car Radio Channel measurements at 5 GHz: Pathloss, Power-delay Profile, and Delay-Doppler Spectrum", *International Symposium on Wireless Communication Systems (ISWCS)*, ISBN: 978-1-4244-0979-2, pp. 224-228, October 2007 (TR2007-095)
- Almers, P.; Santos, T.; Tufvesson, F.; Molisch, A.F.; Karedal, J.; Johansson, A.J., "Antenna Subset Selection in Measured Indoor Channels", *IET Microwaves, Antennas & Propagation*, ISSN: 1751-8725, Vol. 1, pp. 1092-1100, October 2007 (TR2007-103)
- Wigdor, D.; Penn, G.; Ryall, K.; Esenther, A.; Shen, C., "Living with a Tabletop: Analysis and Observations of Long Term Office Use of a Multi-Touch Table", *IEEE International Workshop on Horizontal Interactive Human-computer Systems*, ISBN: 978-0-7695-2013-1, October 2007 (TR2007-076)

- * Lee, J.; Hudson, S.; Dietz, P., "Hybrid Infrared and Visible Light Projection for Location Tracking", *ACM Symposium on User Interface Software and Technology (UIST)*, ISBN: 978-1-59593-679-2, pp. 57-60, October 2007 (TR2007-109)
- * Wigdor, D.; Forlines, C.; Baudisch, P.; Barnwell, J.; Shen, C., "Lucid Touch: A See-through Mobile Device", *ACM Symposium on User Interface Software and Technology (UIST)*, ISBN: 978-1-59593-679-2, pp. 269-278, October 2007 (TR2007-075)
- * Cao, X.; Forlines, C.; Balakrishnan, R., "Multi-user Interaction Using Handheld Projectors", *ACM Symposium on User Interface Software and Technology (UIST)*, ISBN: 978-1-59593-679-2, pp. 43-52, October 2007 (TR2007-104)

Kalgaonkar, K.; Hu, R.; Raj, B. , "Ultrasonic Doppler Sensor for Voice Activity Detection", *IEEE Signal Processing Letters*, ISSN: 1558-2361, Vol. 14, Issue 10, pp. 754-757, October 2007 (TR2007-106)

Slater, C.; Cleary, J.; McGraw, C.M.; Yerazunis, W.S.; Lau, K.T.; Diamond, D., "Autonomous Field-deployable Device for the Measurement of Phosphate in Natural Water", *SPIE Advanced Environmental, Chemical and Biological Sensing Technologies*, Vol. 6755, September 2007 (TR2007-105)

Zwicker, M.; Yea, S.; Vetro, A.; Forlines, C.; Matusik, W.; Pfister, H., "Display Pre-filtering for Multi-view Video Compression", *International Conference on Multimedia (ACM Multimedia)*, ISBN: 978-1-59593-702-5, Session: Systems 4 - Coding Support - pp. 1046-1053, September 2007 (TR2007-073)

Duan, C.; Orlik, P.; Sahinoglu, Z.; Molisch, A.F., "A Non-Coherent 802.15.4a UWB Impulse Radio", *IEEE International Conference on Ultra-Wideband (ICUWB)*, ISBN: 978-1-4244-0521-3, pp. 146-151, September 2007 (TR2007-070)

Wren, C.; Ivanov, Y.; Kaur, I; Leigh, D.; Westhues, J., "SocialMotion: Measuring the Hidden Social Life of a Building", *Third International Symposium on Location- and Context-Awareness (LoCA 2007)*, ISBN: 978-3-540-75159-5, Volume 4718/2007, pp. 85-102, September 2007 (TR2007-034)

Yea, S.; Vetro, A., "RD-Optimized View Synthesis Prediction for Multiview Video Coding", *IEEE International Conference on Image Processing (ICIP)*, ISSN: 1522-4880, Vol. 1, pp I-209 - I-212, September 2007 (TR2007-026)

Vetro, A.; Yea, S.; Zwicker, M.; Matusik, W.; Pfister, H., "Overview of Multiview Video Coding and Anti-Aliasing for 3D Displays", *IEEE International Conference on Image Processing (ICIP)*, ISSN: 1522-4880, Vol. 1, pp. 1-17 - I-20, September 2007 (TR2007-027)

Porikli, F., "Detection of Temporarily Static Regions by Processing Video at Different Frame Rates", *IEEE Conference on Advanced Video and Signal Based Surveillance (AVSS)*, ISBN: 978-1-4244-1696-7, pp. 236-241, September 2007 (TR2007-040)

Kalgaonkar, K.; Raj, B., "Acoustic Doppler Sonar for Gait Recognition", *IEEE Conference on Advanced Video and Signal Based Surveillance (AVSS)*, ISBN: 978-1-4244-1696-7, pp. 27-32, September 2007 (TR2007-107)

Vannucci, G.; Bletsas, A.; Leigh, D., "Implementing Backscatter Radio for Wireless Sensor Networks", *IEEE International Symposium on Personal, Indoor and Mobile Radio Communications (PIMRC)*, ISBN: 978-1-4244-1144-3, pp. 1-5, September 2007 (TR2007-088)

Paier, A.; Karedal, J.; Czink, A.; Hofstetter, H.; Dumard, C.; Zemen, T.; Tufvesson, F.; Mecklenbrauker, C.F.; Molisch, A.F., "First Results from Car-to-Car and Car-to-Infrastructure Radio Channel Measurements at 5.2GHZ", *IEEE International Symposium on Personal, Indoor and Mobile Radio Communications (PIMRC)*, ISBN: 978-1-4244-1144-3, September 2007 (TR2007-102)

Teo, K.H.; Tao, Z.; Zhang, J., "The Mobile Broadband WiMAX Standard", *IEEE Signal Processing Magazine*, Vol. 24, Issue 5, pp. 144-148, September 2007 (TR2006-096)

* Zhang, J.; Yedidia, J.S.; Fossorier, M.P.C., "Low-Latency Decoding of EG LDPC Codes", *Journal of Lightwave Technology*, Volume 25, Issue 9, pp. 2879-2886, September 2007 (TR2008-002)

Molisch, A.F.; Latva-aho, M.; Wang, X., "ChinaCom 2007 - Messages from the TPC Chairs", *International Conference on Communications and Networking in China (CHINACOM)*, ISBN: 978-1-4244-1009-5, pp. 5, August 2007 (TR2007-101)

Czink, N.; Tian, R.; Wyne, S.; Tufvesson, F.; Nuutinen, J.-P.; Ylitalo, J.; Bonek, E.; Molisch, A.F., "Tracking Time-Variant Cluster Parameters in MIMO Channel Measurements", *International Conference on Communications and Networking in China (CHINACOM)*, ISBN: 978-1-4244-1009-5, pp. 1147-1151, August 2007 (TR2007-100)

Molisch, A. F., "Ultrawideband Propagation Channels and Their Impact on System Design", *International Symposium on Microwave, Antenna, Propagation and EMC Technologies for Wireless Communications*, ISBN: 978-1-4244-1045-3, pp. K4-1- K4-5, August 2007 (TR2007-099)

* Karedal, J.; Wyne, S.; Aimers, P.; Tufvesson, F.; Molisch, A.F., "A Measurement-Based Statistical Model for Industrial Ultra-Wideband Channels", *IEEE Transactions on Wireless Communications*, ISSN: 1536-1276, Vol. 6, Issue 8, pp. 3028-2037, August 2007 (TR2007-098)

- * Gezici, S.; Molisch, A.F.; Poor, H.V.; Kobayashi, H., "The Tradeoff Between Processing Gains of an Impulse Radio UWB System in the Presence of Timing Jitter", *IEEE Transactions on Communications*, ISSN: 0090-6778, Vol. 55, Issue 8, pp. 1504-1515, August 2007 (TR2007-097)

- Nii, J.; deDecker, B.; Hashimoto, Y.; Moore, D.; Summet, J.; Zhao, Y.; Westhues, J.; Dietz, P.; Barnwell, J.; Inami, M.; Bekaert, P.; Raskar, R., "Illumination Sensitive Dynamic Virtual Sets", *ACM SIGGRAPH*, Emerging Technologies: Juried Works, Article 12, August 2007 (TR2007-110)

- Bimber, O.; Raskar, R., "Modern Approaches to Augmented Reality", *ACM SIGGRAPH*, Course 17: Spatial Augmented Reality: Merging Real and Virtual Worlds, Article 1, August 2007 (TR2006-105)

- Wren, C.R.; Ivanov, Y.A.; Leigh, D.; Westhues, J., "Buzz: Measuring and Visualizing Conference Crowds", *ACM SIGGRAPH*, Session Emerging Technologies, Article 25, August 2007 (TR2007-035)

- * Vlastic, D.; Adelsberger, R.; Vannucci, G.; Barnwell, J.; Gross, M.; Matusik, W.; Popovic, J., "Practical Motion Capture in Everyday Surroundings", *ACM Transactions on Graphics (TOG), Proceedings of the 2007 SIGGRAPH Conference*, ISSN: 0730-0301, Vol. 26, Issue 3, Article 35, August 2007 (ACM Press) (TR2007-111)

- * Green, P.; Sun, W.; Matusik, W.; Durand, F., "Multi-Aperture Photography", *ACM Transactions on Graphics (TOG), Proceedings of the 2007 SIGGRAPH Conference*, ISSN: 0730-0301, Vol. 26, Issue 3, Article 68, August 2007 (TR2007-112)

- * Reddy, A.M.; Raj, B., "Soft Mask Methods for Single-Channel Speaker Separation", *IEEE Transactions on Audio, Speech and Language Processing*, ISSN: 1558-7916, Vol. 15, Issue, 6, pp. 1766-1776, August 2007

- Mei, X.; Zhou, S.K.; Wu, H.; Porikli, F., "Integrated Detection, Tracking and Recognition for IR Video-based Vehicle Classification", *Journal of Computers*, ISSN: 1796-203X, Vol. 2, Issue 6, pp. 1-8, August 2007 (TR2007-044)

- Okada, Y.; Hirao, C.; Horiuchi, T.; Hara, Y.; Yedidia, J.S.; Azarbayejani, A.; Oishi, N., "Highly Accurate DSM Reconstruction Using Ku-band Airborne InSAR", *IEEE International Geoscience and Remote Sensing Society Symposium (IGARSS)*, ISBN: 978-1-4244-1211-2, pp. 5049-5052, July 2007 (TR2007-064)

- * Sunkavalli, K.; Matusik, W.; Pfister, H.; Rusinkiewicz, S., "Factored Time-Lapse Video", *ACM Transactions on Graphics (TOG), Proceedings of the 2007 SIGGRAPH Conference*, ISSN:0730-0301, Vol. 26, Issue 3, Article 101, July 2007 (TR2007-117)

- * Avidan, S.; Shamir, A., "Seam Carving for Content-Aware Image Resizing", *ACM Transactions on Graphics (TOG), Proceedings of the 2007 SIGGRAPH Conference*, ISSN:0730-0301, Vol. 26, Issue 3, Article 10, July 2007 (TR2007-087)
 - * Veeraraghavan, A.; Raskar, R.; Agrawal, A.; Mohan, A.; Tumblin, J., "Dappled Photography: Mask Enhanced Cameras for Heterodyned Light Fields and Coded Aperture Refocusing", *ACM Transactions on Graphics (TOG), Proceedings of the 2007 SIGGRAPH Conference*, ISSN: 0730-0301, Vol. 26, Issue 3, Article 69, July 2007 (TR2007-115)
 - * Raskar, R.; Nii, H.; deDecker, B.; Hashimoto, Y.; Summet, J.; Moore, D.; Zhao, Y.; Westhues, J.; Dietz, P.; Barnwell, J.; Nayar, S.; Inami, M.; Bekaert, P.; Noland, M.; Branzoi, V.; Bruns, E., "Prakash: Lighting Aware Motion Capture using Photosensing Markers and Multiplexed Illuminators", *ACM Transactions on Graphics (TOG), Proceedings of the 2007 SIGGRAPH Conference*, ISSN: 0730-0301, Vol. 26, Issue 3, Article 36, July 2007 (TR2007-113)
 - * Peers, P., Tamura, N.; Matusik, W.; Debevec, P, "Post-production Facial Performance Relighting using Reflectance Transfer", *ACM Transactions on Graphics (TOG), Proceedings of the 2007 SIGGRAPH Conference*, ISSN: 0730-0301, Vol. 26, Issue 3, Article 52, July 2007 (TR2007-114)
 - * Mehta, N.B.; Wu, J.; Molisch, A.F.; Zhang, J., "Approximating a Sum of Random Variables with a Lognormal", *IEEE Transactions on Wireless Communications*, ISSN: 1536-1276, Vol. 6, Issue 7, pp. 2690-2699, July 2007 (TR2007-067)
 - * Bickel, B.; Botsch, M.; Angst, R.; Matusik, Wojciech, Otaduy, M.; Pfister, H.; Gross, M., "Multi-scale Capture of Facial Geometry and Motion", *ACM Transactions on Graphics (TOG), Proceedings of the 2007 SIGGRAPH Conference*, ISSN 0730-0301, Vol. 26, Issue 3, Article 33, July 2007 (TR2007-116)
 - * Zhao, S.; Orlik, P.; Molisch, A.F.; Liu, H.; Zhang, J., "Hybrid Ultrawideband Modulations Compatible for Both Coherent and Transmit-Reference Receivers", *IEEE Transactions on Wireless Communications*, ISSN: 1536-1276, Vol. 6; Issue 7, pp. 2551-2559, July 2007 (TR2007-090)
 - * Molisch, A.F.; Toeltsch, M.; Vermani, S., "Iterative Methods for Cancellation of Intercarrier Interference in OFDM Systems", *IEEE Transactions on Vehicular Technology*, ISSN: 0018-9545, Vol. 56, Issue 4, Part 2, pp. 2158-2167, July 2007 (TR2007-096)
- Goela, N.; Wilson, K.; Niu, F.; Divakaran, A.; Otsuka, I., "An SVM Framework for Genre-Independent Scene Change Detection", *IEEE International Conference on Multimedia and Expo (ICME)*, ISBN: 1-4244-1017-7, pp. 532-535, July 2007 (TR2007-033)
- Mei, X.; Zhou, S.K.; Porikli, F., "Probabilistic Visual Tracking via Robust Template Matching and Incremental Subspace Update", *IEEE International Conference on Multimedia and Expo*, ISBN: 1-4244-1027-7, pp. 1818-1821, July 2007 (TR2007-045)

Research

The body and soul of any research lab is the portfolio of research it pursues. Therefore it is appropriate that the main body of this annual report consists of descriptions of research projects being done at MERL. For ease of reference, the reports are grouped into six topic areas.

Digital Communications - High speed mobile communications, ubiquitous networking, reliable wireless, next generation standards and new applications.

Multimedia – Efficient representation, transmission, security, processing and interaction of multimedia; including video compression, display processing, information coding for security, compressive sensing, and speech processing.

Data and Sensor Systems - Predictive analytics (statistical machine learning, data analysis); decision analytics (optimization and control); visual analytics (interactive data exploration and visualization, decision support); and software infrastructure (distributed software systems, data stream processing).

Imaging - Developing and applying novel methods for sensing people, objects & events; extending what cameras can do by adding motion, force, ultrasound, 3D & other sensors to quantify the world.

Mechatronics - Advanced control algorithms, system dynamics, modeling & performance analysis, mechatronics design, innovative system concepts, and 2D/3D adaptively-sampled distance fields applications.

Algorithms - Solution methods for optimization problems involving very large numbers of variables in the areas of information theory & coding, stochastic optimization, inference & learning, and sensing & perception.

Each research area section starts with a short discussion of the topic area highlighting MERL's major efforts and serving as an index into the more detailed descriptions of MERL's recent work that follow.

Digital Communications

Digital communications and networking are pervasive in today's society. Advanced technologies at the physical layer, medium access control layer and network layer provide high speed communication capability for transmissions of voice, data, and multimedia information with quality of service over wire or wireless, connecting people anywhere at anytime. From advanced wireless multimedia systems to simple integrated home networking, communications and networking technologies are at the center of a continuing revolution.

MERL's goal is to identify new business and technology trends in the area of digital communications and networking. We are conducting fundamental research on communication theories and developing new core technologies, then applying our discoveries and technologies to international standards and emerging products.

For broadband mobile communications, MERL is developing MIMO (Multi-Input-Multi-Output) technologies, including cooperative MIMO and mobile multi-hop relaying. MERL is also developing advanced cognitive wireless sensing and interference management techniques, adaptive frame structure and efficient medium access control (MAC) protocols. In the area of ubiquitous networking, we are developing engineering-free wireless sensor networks and vehicular communications over highly dynamic environments. Finally, MERL contributes to 3GPP LTE and Advanced WiMAX systems.

Recent Research

A Game-Theoretic Framework for Interference Management through Cognitive Sensing	36
A Low-Complexity Synchronization Design for MB-OFDM Ultra-Wideband Systems.....	36
Antenna Selection for Next Generation IEEE 802.16 Mobile Stations.....	37
Outdoor-to-Indoor Office MIMO Measurements and Analysis at 5.2 GHz.....	37
Two-Step Time of Arrival Estimation for Pulse-Based Ultra-Wideband Systems	38
Asynchronous Interference Mitigation in Cooperative Base Station Systems.....	38
Antenna Selection Training in MIMO-OFDM/OFDMA Cellular Systems.....	39
Frame Structure Design for IEEE 802.16j Mobile Multihop Relay (MMR) Networks	39
Multi-Stage Real Time Health Monitoring via ZigBee in Smart Homes	40
Aggregation and Concatenation in IEEE 802.16j Mobile Multihop Relay (MMR) Networks	40
Progressive Accumulative Routing in Wireless Networks	41
WLC41-6: Cooperative Relay Networks Using Fountain Codes.....	41
Implementation Aspects of Antenna Selection for MIMO Systems	42
A Hybrid UWB Modulation Design Compatible for Both Coherent and Transmit-Reference Receivers.....	42

A Game-Theoretic Framework for Interference Management through Cognitive Sensing

Citation: Chen, Y.; Teo, K.H.; Kishore, S.; Zhang, J., "A Game-Theoretic Framework for Interference Management through Cognitive Sensing," *IEEE International Conference on Communications (ICC)*, ISBN: 978-1-4244-2075-9, pp. 3573-3577, May 2008

Contacts: Koon Hoo Teo, Jinyun Zhang

A game theoretic framework is developed in this paper to facilitate inter-cell interference management through cognitive sensing distributively performed by mobile stations (MSs). Using stochastic geometry, we reveal the relationship between the effectiveness of interference management and MS's "willingness" to perform cognitive sensing. Such cognitive sensing performed by MS is motivated by the associated beneficial results as well as by the rewards from base stations (BS) that encourage sensing. Different tradeoffs for BS and MSs exist in their interactions, which are modeled as a stackelberg game in this paper. While both BS and MS seek to manage interference at its own minimum cost, we design an algorithm to achieve nash Equilibrium in such a game and investigate the optimal strategies taken by the players (BS and MSs).

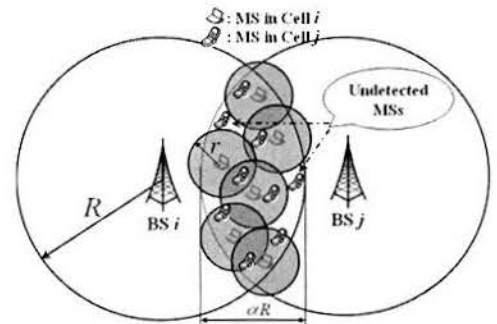

A Low-Complexity Synchronization Design for MB-OFDM Ultra-Wideband Systems

Citation: Ye, Z.; Duan, C.; Orlik, P.; Zhang, J., "A Low-Complexity Synchronization Design for MB-OFDM Ultra-Wideband Systems," *IEEE International Conference on Communicaitons (ICC)*, ISBN: 978-1-4244-2075-9, pp. 3807-3813, May 2008

Contacts: Chunjie Duan, Philip Orlik, Jinyun Zhang

In this paper, we investigate the low-complexity synchronization design for multi-band orthogonal-frequency-division-multiplexing (MB-OFDM) ultra-wideband (UWB) systems. We propose a unified synchronizer design based on auto-correlation-function.

The key component in the proposed synchronizer is a parallel signal detector structure in which multiple auto-correlation units are instantiated and their outputs are shared by other functional units in the synchronizer, including time-frequency pattern detection, symbol timing carrier frequency offset estimation and correction and frame synchronization. We show that, via analysis and simulations, such a design achieves not only a low computation cost which makes it attractive in implementation, but also equal or better performance compared to the cross-correlation based designs.

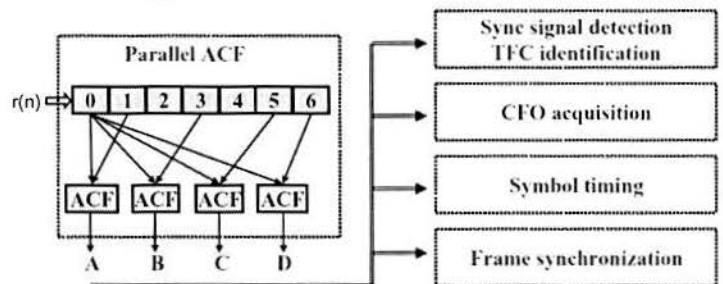

Antenna Selection for Next Generation IEEE 802.16 Mobile Stations

Citation: Nie, C.; Tao, Z.; Mehta, N.B.; Molisch, A.F.; Zhang, J.; Kuze, T.; Panwar, S., "Antenna Selection for Next Generation IEEE 802.16 Mobile Stations," *IEEE International Conference on Communications (ICC)*, ISBN: 978-1-4244-2075-9, pp. 3457-3462, May 2008

Contacts: Zhifeng (Jeffrey) Tao, Andreas F. Molisch, Jinyun Zhang

The IEEE 802.16/WiMAX standard has fully embraced multi-antenna technology and can, thus, deliver robust and high transmission rates and higher system capacity. Nevertheless, due to its inherent form-factor constraints and cost concerns, a WiMAX mobile station (MS) should preferably contain fewer radio frequency (RF) chains than antenna elements. This is because RF chains are often substantially more expensive than antenna elements. Thus, antenna selection, wherein a subset of

antennas is dynamically selected to connect to the limited RF chains for transceiving, is a highly appealing performance enhancement technique for multi-antenna WiMAX terminals. In this paper, a novel antenna selection protocol tailored for next-generation IEEE 802.16 mobile stations is proposed. As demonstrated by the extensive OPNET simulations, the proposed protocol delivers a significant performance improvement over conventional 802.16 terminals that lack the antenna selection capability. Moreover, the new protocol leverages the existing signaling methods defined in 802.16, thereby incurring a negligible signaling overhead and requiring only diminutive modifications of the standard. To the best of our knowledge, this paper represents the first effort to support antenna selection capability in IEEE 802.16 mobile stations.

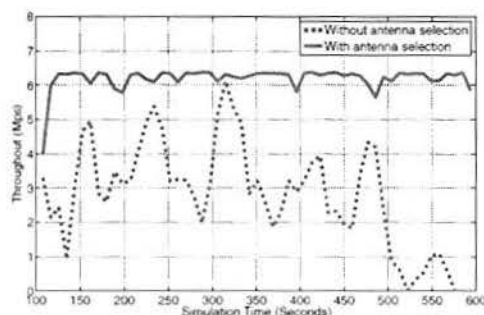

Outdoor-to-Indoor Office MIMO Measurements and Analysis at 5.2 GHz

Citation: Wyne, S.; Molisch, A.F.; Almers, P.; Eriksson, G.; Karedal, J.; Tufvesson, F., "Outdoor-to-Indoor Office MIMO Measurements and Analysis at 5.2 GHz," *IEEE Transactions On Vehicular Technology*, ISSN: 0018-9545, Vol. 57, Issue 3, pp. 1374-1386, May 2008

Contacts: Andreas F. Molisch

The outdoor-to-indoor wireless propagation channel is of interest for cellular and wireless local area network applications. This paper presents the measurement results and analysis based on our multiple-input-multiple-output (MIMO) measurement campaign, which is one of the first to characterize the outdoor-to-indoor channel. The measurements were performed at 5.2 GHz; the receiver was placed indoors at 53 different locations in an office building, and the transmitter was placed at three "base station" positions on a nearby rooftop. We report on the root-mean-square (RMS) angular spread, building penetration, and other statistical parameters that characterize the channel.



Two-Step Time of Arrival Estimation for Pulse-Based Ultra-Wideband Systems

Citation: Gezici, S.; Sahinoglu, Z.; Molisch, A.F.; Kobayashi, H.; Poor, H.V., "Two-Step Time of Arrival Estimation for Pulse-Based Ultra-Wideband Systems," *EURASIP Journal on Advances in Signal Processing*, Vol. 2008, Article ID 529134, 11 pages, doi:10.1155/2008/529134, April 2008

Contacts: Zafer Sahinoglu, Andreas F. Molisch

In cooperative localization systems, wireless nodes need to exchange accurate position-related information such as time-of-arrival (TOA) and angle-of-arrival (AOA), in order to obtain accurate location information. One alternative for providing accurate position-related information is to use ultra-wideband (UWB) signals. The high time resolution of UWB signals presents a potential for very accurate positioning based on TOA estimation. However, it is challenging to realize very accurate positioning systems in practical scenarios, due to both complexity / cost constraints and adverse channel conditions such as multipath propagation. In this paper, a two-step TOA estimation algorithm is proposed for UWB systems in order to provide accurate TOA estimation under practical constraints. The proposed scheme uses low-rate correlation outputs and is able to perform accurate TOA estimation in reasonable time intervals. The simulation results are presented to analyze the performance of the estimator.

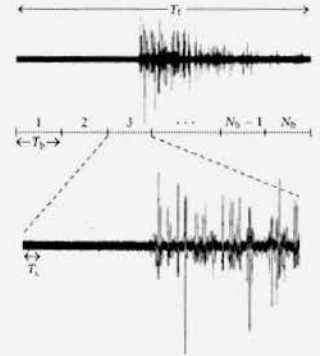

Asynchronous Interference Mitigation in Cooperative Base Station Systems

Citation: Zhang, H.; Mehta, N.B.; Molisch, A.F.; Zhang, J.; Dai, H., "Asynchronous Interference Mitigation in Cooperative Base Station Systems," *IEEE Transactions on Wireless Communications*, ISSN: 1536-1276, Vol. 7, Iss. 1, pp. 155-165, January 2008

Contacts: Andreas F. Molisch, Jinyun Zhang

Cooperative transmission by base stations (BSs) can significantly improve the spectral efficiency of multiuser, multicell, multiple input multiple output (MIMO) systems. We show that, contrary to what is often assumed in the literature, the multiuser interference in such systems is fundamentally asynchronous. Intuitively, perfect timing-advance mechanisms can at best ensure only that the desired signal components—but not the interference components—are perfectly aligned at their intended mobile stations. We develop an accurate mathematical model for the asynchronicity, and show that it leads to a significant performance degradation of existing designs that ignore the asynchronicity of interference. Using three previously proposed linear precoding design methods for BS cooperation, we develop corresponding algorithms that are better at mitigating the impact of the asynchronicity of the interference. We also address timing-advance inaccuracies (jitter), which are inevitable in a practical system. We show that using jitter-statistics-aware precoders can mitigate the impact of these inaccuracies as well.

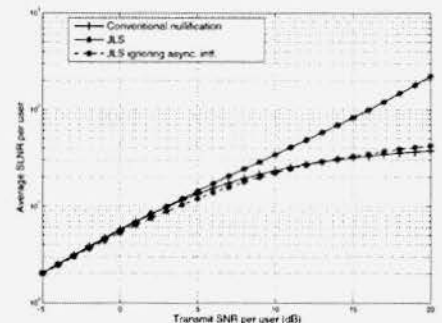

Antenna Selection Training in MIMO-OFDM/OFDMA Cellular Systems

Citation: Mehta, N.B.; Molisch, A.F.; Zhang, J.; Bala, E., "Antenna Selection Training in MIMO-OFDM/OFDMA Cellular Systems," *IEEE International Workshop on Computational Advances in Multi-Sensor Adaptive Processing (CAMPAP)*, ISBN: 978-1-4244-1713-1, pp. 113-116, December 2007

Contacts: Andreas F. Molisch, Jinyun Zhang

Antenna selection allows multiple-antenna systems to achieve most of their promised diversity gain while keeping the number of RF chains and, thus cost/complexity, low. In this paper we investigate antenna selection for fourth-generation OFDMA-based cellular communication systems, in particular, 3GPP LTE (long-term evolution) systems. We propose a training method for antenna selection that is especially suitable for OFDMA.

By means of simulation, we evaluate the SNR-gain that can be achieved with our design. We find that the performance depends on the bandwidth assigned to each user, the scheduling method (round-robin or frequency-domain scheduling), and the Doppler spread. Furthermore, the signal-to-noise ratio of the training sequence plays a critical role. Typically, SNR gains are around 2 dB, with larger values obtainable in certain circumstances.

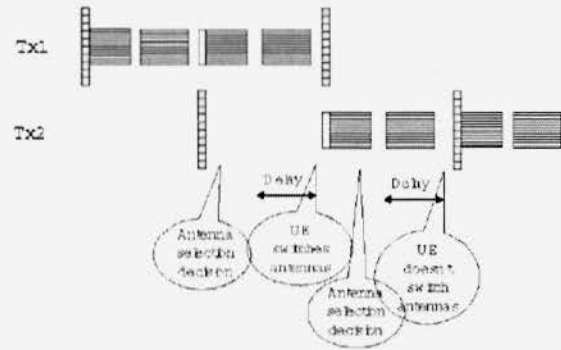

Frame Structure Design for IEEE 802.16j Mobile Multihop Relay (MMR) Networks

Citation: Tao, Z.; Li, A.; Teo, K.H.; Zhang, J., "Frame Structure Design for IEEE 802.16j Mobile Multihop Relay (MMR) Networks," *IEEE Global Telecommunications Conference (GLOBECOM)*, ISBN: 978-1-4244-1043-9, pp. 4301-4306, November 2007

Contacts: Zhifeng (Jeffrey) Tao, Koon Hoo Teo, Jinyun Zhang

Frame structure is critical to an IEEE 802.16e OFDMA network, as it governs the fundamental channel access in both time and frequency domain. The framework structure design is tremendously complicated in the new mobile multi-hop relay-based (MMR) network architecture, as numerous dimensions of design constraints and challenges have been introduced therein.

In this paper, we propose a simple yet flexible framework based upon the current 802.16e OFDMA frame structure design, which enables multihop operation while still maintaining the backward compatibility with legacy mobile stations. Further performance evaluation not only demonstrates the capacity improvement an MMR network can achieve based upon the proposed frame structure, but also establishes a more profound understanding of the range extension aspect of a relay network.

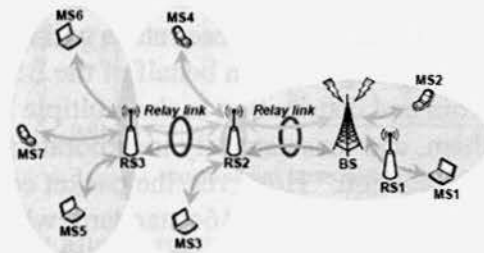

Multi-Stage Real Time Health Monitoring via ZigBee in Smart Homes

Citation: Dagtas, S.; Pekhteryev, G.; Sahinoglu, Z., "Multi-Stage Real Time Health Monitoring via ZigBee in Smart Homes," *IEEE International Conference on Advanced Information Networking and Applications Workshops (AINA Workshops)*, pp. 782-786, May 2007

Contacts: Zafer Sahinoglu

We present a framework for a wireless health monitoring system within a smart home using ZigBee technology. Vital signals are collected and processed using a 3-tiered architecture. The first stage is the mobile device carried on the body that runs a number of wired and wireless probes. This device is also designed to perform some basic processing such as heart rate and fatal failure detection. At the second stage, further processing is performed by a local server using the raw data continuously transmitted by the mobile device. The raw data is also stored at this server. The processed data as well as the outcomes of the analysis are then transmitted to the service provider center for experts' review for diagnosis as well as storage. The main advantages of the proposed framework are (1) The ability to detect signals wirelessly within a Body Area Network (BAN), (2) Low-power and reliable data sensing through ZigBee network nodes, and (3) Optimized analysis of data through an adaptive tiered architecture that maximizes the utility of processing and computational capacity at each of three stages. We are currently building a prototype of the proposed system using in-house ECG probes and ZigBee radio modules.

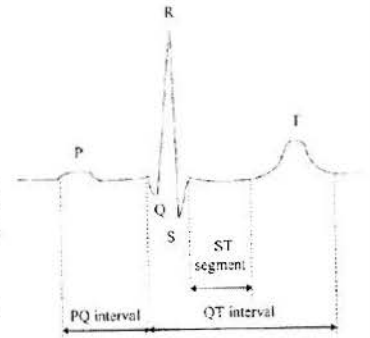

Aggregation and Concatenation in IEEE 802.16j Mobile Multihop Relay (MMR) Networks

Citation: Tao, Z.; Teo, K.H.; Zhang, J., "Aggregation and Concatenation in IEEE 802.16j Mobile Multihop Relay (MMR) Networks," *IEEE Mobile WiMAX Symposium*, pp. 85-90, March 2007

Contacts: Zhifeng (Jeffrey) Tao, Koon Hoo Teo, Jinyun Zhang

The new mobile multi-hop relay-based (MMR) network architecture imposes a demanding performance requirement on relay stations. These relays will functionally serve as an aggregating point on behalf of the BS for traffic collection from and distribution to the multiple MSs associated with them, and thus naturally incorporate a notion of "traffic aggregation." However, the packet construction mechanism in the IEEE 802.16/16e standard, which was designed for handling traffic solely on a per-connection basis, cannot apply on the relay link directly, as it may render a potential bottleneck and preponderantly limit the overall network capacity. As a solution, we propose two new efficiency-improvement schemes at the MAC layer, namely MPDU concatenation and MSDU aggregation, both of which incarnate the inherent notion of "aggregation" and alleviate the dismal efficiency degradation on the relay links.

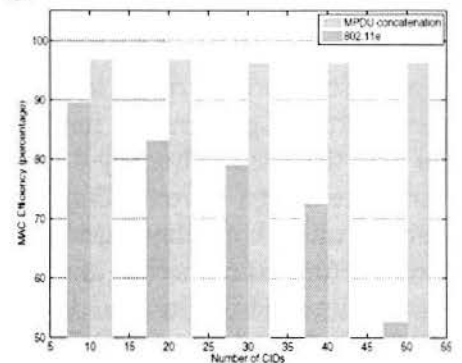

Progressive Accumulative Routing in Wireless Networks

Citation: Yim, R.; Mehta, N.; Molisch, A.F.; Zhang, J., "Progressive Accumulative Routing in Wireless Networks," *IEEE Global Telecommunications Conference (GLOBECOM)*, November 2006

Contacts: Raymond Yim, Andreas F. Molisch, Jinyun Zhang

This paper considers a sensor network where relay nodes cooperate in order to minimize the total energy consumption for the unicast transmission of a message from a single source to a single destination. We assume Destination Energy Accumulation, i.e., the destination can accumulate the energy of multiple copies of the message, each of which is too weak to be reliably decoded by itself, while the relay nodes use a decode-and-forward approach. We propose the Progressive Accumulative Routing (PAR) algorithm, which performs relay discovery, relay ordering and power allocation in a distributed manner so that each relay node only needs information about its neighboring nodes. Simulations verify that the algorithm considerably reduces the total energy consumption, and can be implemented efficiently. Furthermore, it performs close to the optimal DEA route with high probability.

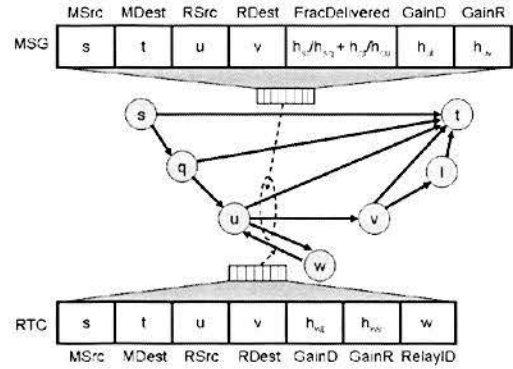

WLC41-6: Cooperative Relay Networks Using Fountain Codes

Citation: Molisch, A.F.; Mehta, N.B.; Yedidia, J.S.; Zhang, J., "WLC41-6: Cooperative Relay Networks Using Fountain Codes," *IEEE Global Telecommunications Conference (GLOBECOM)*, pp. 1-6, November 2006

Contacts: Andreas F. Molisch, Jonathan Yedidia, Jinyun Zhang

We investigate a cooperative communications scheme with N parallel relays, where both the transmissions from the source to the relays and from the relays to the destination use fountain codes. Receiver for codes can accumulate mutual information, while traditional energy collection methods such as repetition or cooperative space-time codes only accumulate energy. As a consequence, using fountain codes can reduce the total energy required for transmitting data from the source to the destination. We first analyze the scenario where the source stops transmitting and the relay nodes start transmitting after L relay nodes have successfully decoded the source data. We optimize L , and also give closed-form equations for the energy savings that can be achieved by the use of mutual-information-collection at the receiver instead of the traditional energy-collection methods.

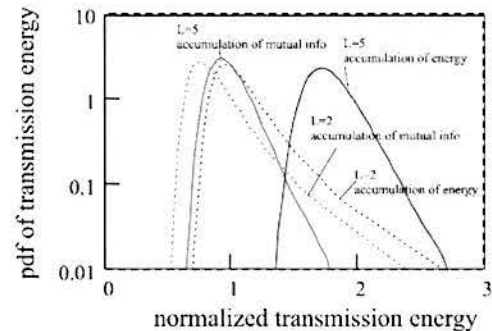

Implementation Aspects of Antenna Selection for MIMO Systems

Citation: Molisch, A.F.; Mehta, N.B.; Zhang, H.; Almers, P.; Zhang, J., "Implementation Aspects of Antenna Selection for MIMO Systems," *International Conference Communications and Networking in China (ChinaCom)*, pp. 1-7, October 2006

Contacts: Andreas F. Molisch, Jinyun Zhang

Antenna selection is a promising technique for reducing complexity of multiple-antenna (MIMO) systems. In antenna selection, more antenna elements than RF transceiver chains are available for up-conversion and down-conversion. A subset of the available antenna elements is selected and connected to the RF chains. The reduction in the number of RF chains helps to reduce the implementation cost of multi-antenna systems. This paper considers a number of "practical" issues in the implementation of such systems. We discuss schemes for the channel estimation for all antenna elements, and show that antenna selection is robust to channel estimation errors. RF preprocessing can be used to enhance the array gain of antenna selection schemes; the performance is robust to errors in the RF elements used for the preprocessing. Finally, we analyze both bulk selection and per-tone selection in MIMO-OFDM systems, and show that the former is usually preferable. Results from simulations with 802.11n-compliant systems, and capacity results in measured channels show that SNR and capacity gains can be achieved with antenna selection in practical situations.

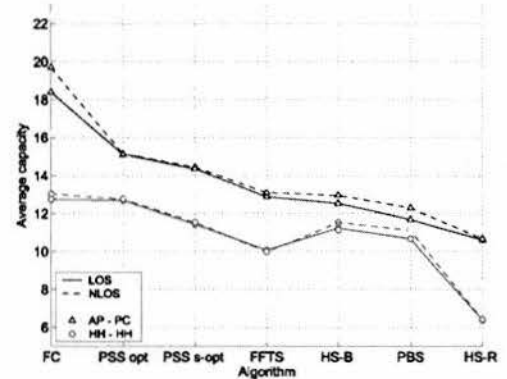

A Hybrid UWB Modulation Design Compatible for Both Coherent and Transmit-Reference Receivers

Citation: Orlik, P.; Zhao, S.; Molisch, A.F., "A Hybrid UWB Modulation Design Compatible for Both Coherent and Transmit-Reference Receivers," *IEEE International Conference on Communications*, ISSN: 8164-9547, Vol. 10, pp. 4741-4745, June 2006

Contacts: Philip Orlik, Andreas F. Molisch

In a pulsed UWB system, either coherent receivers or transmit-reference (TR) receivers can be used to demodulate the signals. For coherent receivers, which are typically based on a Rake Structure, the large number of resolvable multipaths is a major challenge for channel estimation and receiver complexity. TR receivers can effectively collect energy from all the received multipath components with much smaller complexity, but show reduced performance. Current modulation formats are tuned to either coherent or TR receivers, but cannot interoperate with both. In this paper, we propose an innovative modulation scheme that enables the usage of TR and coherent receivers in the same wireless network.

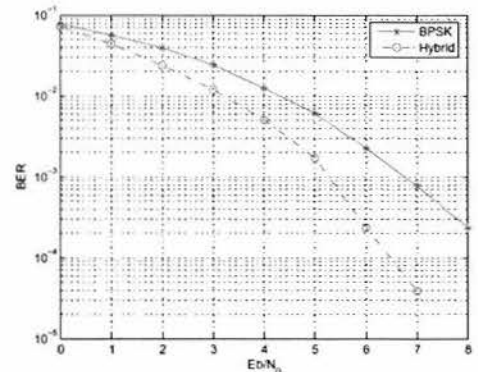

Multimedia

Multimedia enriches our everyday lives through audio-visual communication and entertainment. We experience multimedia through television broadcasts, radio, DVD and mobile devices, while surfing the Internet, and in our automobiles. Multimedia is also used extensively for security systems.

At MERL, our multimedia work is focused in several main areas of concentration, which are described further below. Efficient representation, transmission, processing and interaction of multimedia are some of the underlying technical themes.

- Video Compression: Key activities target compression of rich video formats, e.g., multiple views, higher resolution, better color, and greater bit-depth. Our research results are applied to international standards and across a wide range of AV products.
- Information Coding: Current efforts are focused on application of distributed source coding principles to secure storage of fingerprint data. New applications related to robust media transmission, multimedia authentication, and low cost image sensors are being considered.
- Speech/Audio Processing: The work in this area emphasizes spoken-language interfaces for automotive and handheld devices. There is also ongoing research on acoustic doppler-sensing for speech denoising and human gait recognition.
- Multimedia Platform: The primary aim is to enhance the capabilities of various multimedia platforms, including DTV platforms (noise reduction and AV networking).

In the pages that follow, we provide a brief overview of related projects in the above areas that we have been working on within the past year and have substantial results to report on.

Recent Research

View Synthesis Prediction for Rate-Overhead Reduction in FTV	44
Speech-Based UI Design for the Automobile	44
Spatio-Temporal Fuzzy Filtering for Coding Artifacts Reduction.....	45
Bit-depth Scalable Coding for High Dynamic Range Video	45
Motion Mapping for MPEG-2 to H.264/AVC Transcoding	46
Ultrasonic Doppler Sensor for Voice Activity Detection	46
Display Pre-filtering for Multi-view Video Compression	47

View Synthesis Prediction for Rate-Overhead Reduction in FTV

Citation: Yea, S.; Vetro, A., "View Synthesis Prediction for Rate-Overhead Reduction in FTV," *3DTV-Conference*, ISBN: 978-1-4244-1670-5, pp. 145-148, May 2008

Contacts: Sehoon Yea, Anthony Vetro

This paper proposes the use of view synthesis prediction for reducing rate-overhead incurred by transmitting depth-maps in free viewpoint TV applications. In particular, we consider the scenario in which depth-maps with varying degrees of quality are available at the decoder for free viewpoint video applications. The depth-map for each view is encoded separately from the multiview video and is used to generate intermediate views as well as view synthesis prediction for coding efficiency improvement. We show that the rate overhead incurred by coding high-quality depth maps can be offset by reducing the necessary bitrate for coding multiview (texture) video with the proposed technique. We also discuss the effect of downsampling as well as the use of different QPs for the depth map.

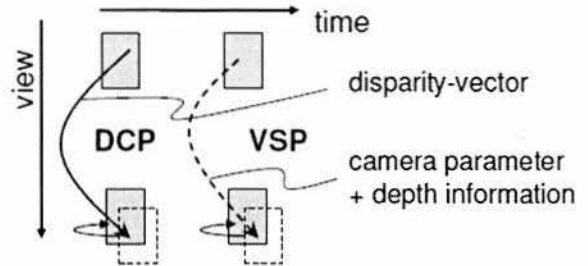

Speech-Based UI Design for the Automobile

Citation: Schmidt-Nielsen, B.; Harsham, B.; Raj, B.; Forlines, C., "Speech-Based UI Design for the Automobile," *Handbook of Research on User Interface Design and Evaluation for Mobile Technology*, ISBN: 978-1-59904-871-0, Vol. 1, Chapter XV, pp. 237-252, February 2008

Contacts: Bent Schmidt-Nielsen, Clifton Forlines, Bret Harsham

In this chapter we discuss a variety of topics relating to speech-based user interfaces for use in an automotive environment. We begin by presenting a number of design principles for the design of such interfaces, derived from several decades of combined experience in the development and evaluation of spoken user interfaces (UI) for automobiles, along with three case studies of current automotive navigation interfaces.

Finally, we present a new model for speech-based user interfaces in automotive environments that recasts the goal of the UI from supporting the navigation among and selection from multiple states to that of selecting the desired command from a short list. We also present experimental evidence that UIs based on this approach can impose significantly lower cognitive load on a driver than conventional UIs.

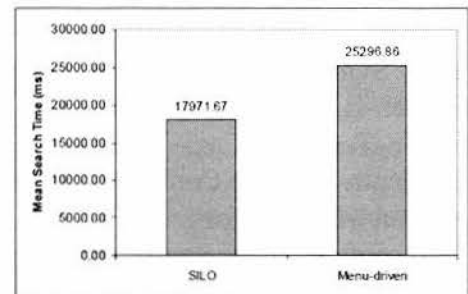

Spatio-Temporal Fuzzy Filtering for Coding Artifacts Reduction

Citation: Vo, D.T.; Yea, S.; Vetro, A., "Spatio-Temporal Fuzzy Filtering for Coding Artifacts Reduction," *SPIE Conference on Visual Communications and Image Processing (VCIP)*, Vol. 6822, January 2008

Contacts: Sehoon Yea, Anthony Vetro

We propose a 3D fuzzy-filtering scheme for reduction of compression artifacts such as blocking and ringing noises. The proposed scheme incorporates information from temporally-neighboring frames as well as from spatially-neighboring pixels by accounting for the spatio-temporal relationships in the definitions of spatial-rank orders and spread information for the fuzzy-filter.



Extra information from a 3D set of pixels of the surrounding frames helps enhance the clustering characteristic of the fuzzy filter while preserving the frame edges. The proposed scheme also exploits the chroma components from neighboring frames to more faithfully reconstruct the color of the current frame. Experimental results show that both the subjective and the objective qualities of post-processed video are significantly improved.

Bit-depth Scalable Coding for High Dynamic Range Video

Citation: Liu, S.; Kim, W-S.; Vetro, A., "Bit-depth Scalable Coding for High Dynamic Range Video," *SPIE Conference on Visual Communications and Image Processing (VCIP)*, Vol. 6822, January 2008

Contacts: Anthony Vetro

This paper presents a technique for coding high dynamic range videos. The proposed coding scheme is scalable, such that both standard dynamic range and high dynamic range representations of a video can be extracted from one bit stream. A localized inverse tone mapping method is proposed for efficient inter-layer prediction, which applies a scaling factor and an offset to each macroblock, per color channel.

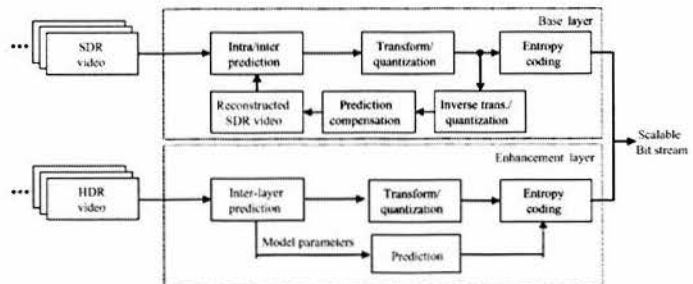

The scaling factors and offsets are predicted from neighboring macroblocks, and then the differences are entropy coded. The proposed inter-layer prediction technique is independent of the forward tone mapping method and is able to cover a wide range of bit-depths and various color spaces. Simulations are performed based on H.264/AVC SVC common software and core experiment conditions. Results show the effectiveness of the proposed method.

Motion Mapping for MPEG-2 to H.264/AVC Transcoding

Citation: Jun Xin, Jianjun Li, Anthony Vetro, Huifang Sun, Shun-ichi Sekiguchi, "Motion Mapping for MPEG-2 to H.264/AVC Transcoding," *IEEE International Symposium on Circuits and Systems (ISCAS)*, May 2007

Contacts: Anthony Vetro, Huifang Sun

This paper describes novel motion mapping algorithms for low-complexity MPEG-2 to AVC transcoding. The proposed algorithms efficiently map incoming MPEG-2 motion vectors to outgoing AVC motion vectors regardless of the block sizes to which the motion vectors correspond. Extensive simulation results show that our proposed transcoder incorporating the proposed algorithms achieves very good rate-distortion performance with low complexity. Compared with the cascaded decoder-encoder solution, the proposed approach could achieve similar coding efficiency while significantly reducing complexity.

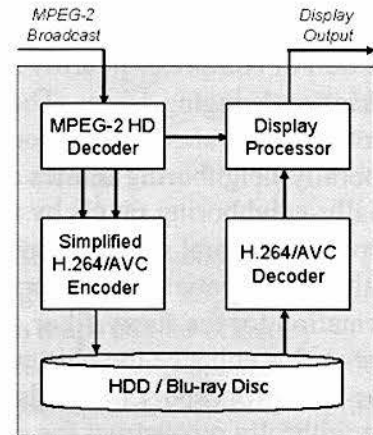

Ultrasonic Doppler Sensor for Voice Activity Detection

Citation: Kalgaonkar, K.; Hu, R.; Raj, B., "Ultrasonic Doppler Sensor for Voice Activity Detection," *IEEE Signal Processing Letters*, ISSN: 1558-2361, Vol. 14, Issue 10, pp. 754-757, October 2007

Contacts: Bhiksha Raj

This paper describes a robust voice activity detector using an ultrasonic Doppler sonar device. An ultrasonic beam is incident on the talker's face. Facial movements result in Doppler frequency shifts in the reflected signal that are sensed by an ultrasonic sensor. Speech-related facial movements result in identifiable patterns in the spectrum of the received signal that can be used to identify speech activity.

These sensors are not affected by even high levels of ambient audio noise. Unlike most other non-acoustic sensors, the device need not be taped to a talker. A simple yet robust method of extracting the voice activity information from the ultrasonic Doppler signal is developed and presented in this paper. The algorithm is seen to be very effective and robust to noise, and can be implemented in real time.

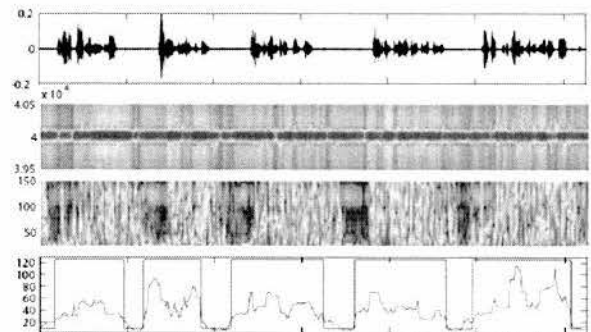

Display Pre-filtering for Multi-view Video Compression

Citation: Zwicker, M.; Yea, S.; Vetro, A.; Forlines, C.; Matusik, W.; Pfister, H., "Display Pre-filtering for Multi-view Video Compression," *International Conference on Multimedia (ACM Multimedia)*, ISBN: 978-1-59593-702-5, pp. 1046-1053, September 2007

Contacts: Sehoon Yea, Anthony Vetro, Clifton Forlines

Multi-view 3D displays are preferable to other stereoscopic display technologies because they provide autostereoscopic viewing from any viewpoint without special glasses.

However, they require a large number of pixels to achieve high image quality. Therefore, data compression is a major issue for this approach. In this paper, we present a framework for efficient compression of multi-view video streams for multi-view 3D displays. Our goal is to optimize image quality without increasing the required data bandwidth. We achieve this by taking into account a precise notion of the multi-dimensional display bandwidth. The display bandwidth implies that scene elements that appear at a given distance from the display become increasingly blurry as the distance grows. Our main contribution is to enhance conventional multi-view compression pipelines with an additional pre-filtering step that bandlimits the multi-view signal to the display bandwidth.

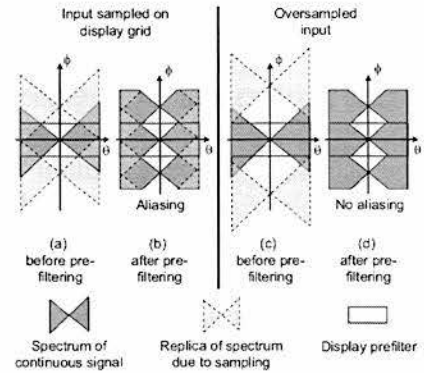

Sensor and Data Systems

Until recently, computer applications have largely presented the user with human-generated content that has been processed according to fixed or human-generated algorithms. Now it is becoming possible for a computer system to collect data from the local environment on its own, process that data adaptively, and then use those results to modify the environment and to further refine the system's ability to analyze more data. These capabilities are driving new applications in sensor networking, data mining, and ubiquitous computing.

MERL's work in "Sensor and Data Systems" is creating new technologies for this exciting area, ranging from fundamental technology to applications meant to grow new businesses and enhance current ones. The core technologies in "Sensor and Data Systems" include predictive and decision analytics, distributed enterprise information systems, and visualization technology. Projects span the gamut from data analysis to algorithms for finding features in the data and correlating it all. Because cost of infrastructure is a limiting consideration for most applications of these technologies, MERL's researchers have kept this in mind so that the new applications will be able to use commodity electronic and computing hardware and be cheaply deployed.

Our work this year includes important advances in monitoring the equipment condition for HVAC, motors, and machines. We have also been working on ways for humans and computers to cooperate on various optimization processes as well as on monitoring human activity in buildings.

Recent Research

Workflow Trees for Representation and Mining of Implicitly Concurrent Business Processes...	50
Content Aware Video Presentation on High-Resolution Displays.....	50
Visualizing Antenna Design Spaces	51
Speech Denoising Using Nonnegative Matrix Factorization with Priors.....	51
An SVM Framework for Genre-Independent Scene Change Detection.....	52
Assessment of End-User Response to Sports Highlights Extraction for Personal Video	52

Workflow Trees for Representation and Mining of Implicitly Concurrent Business Processes

Citation: Nikovski, D., "Workflow Trees for Representation and Mining of Implicitly Concurrent Business Processes," *International Conference on Enterprise Information Systems (ICEIS)*, June 2008

Contacts: Daniel Nikovski

We propose a novel representation of business processes called workflow trees that facilitates the mining of process models where the parallel execution of two or more sub-processes has not been recorded explicitly in workflow logs. Based on the provable property of workflow trees that a pair of tasks are siblings in the tree if and only if they have identical respective workflow-log relations with each and every remaining third task in the process, we describe an efficient business process mining algorithm of complexity only cubic in the number of process tasks, and analyze the class of processes that can be identified and reconstructed by it.

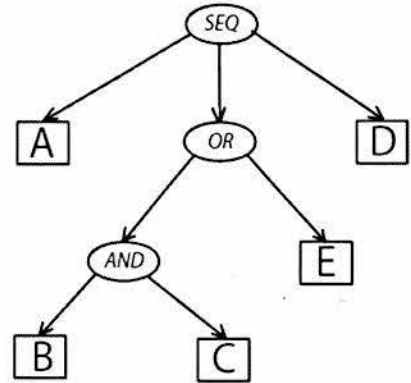

Content Aware Video Presentation on High-Resolution Displays

Citation: Forlines, C., "Content Aware Video Presentation on High-Resolution Displays," *Advanced Visual Interfaces (AVI)*, ISBN 0-978-60558-141-5, pp. 57-64, May 2008

Contacts: Clifton Forlines

We describe a prototype video presentation system that presents a video in a manner consistent with the video's content. Our prototype takes advantage of the physically large display and pixel space that current high-definition displays and multi-monitor systems offer by rendering the frames of the video into various regions of the display surface. The structure of the video informs the animation, size, and the position of these regions. Additionally, previously displayed frames are often allowed to remain on-screen and are filtered over time. Our prototype presents a video in a manner that not only preserves the continuity of the story, but also supports the structure of the video; thus, the content of the video is reflected in its presentation, arguably enhancing the viewing experience.

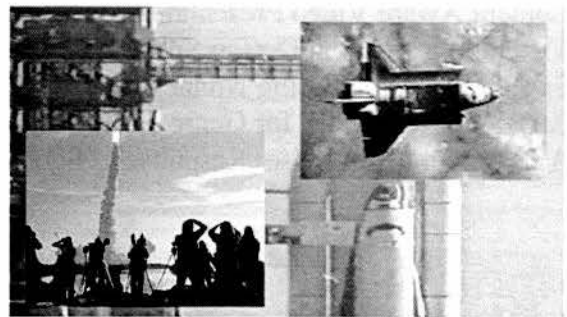

Visualizing Antenna Design Spaces

Citation: Wittenburg, K.; Lanning, T.; Leigh, D.; Ryall, K., "Visualizing Antenna Design Spaces," *International Working Conference on Advanced Visual Interfaces (AVI)*, ISBN: 0-978-60558-141-5, pp. 83-90, May 2008

Contacts: Kent Wittenburg

This paper describes a long-term project exploring advanced visual interfaces for antenna design. MERL developed three successive prototypes that embodied an evolution towards larger scales and more concrete semantics for visualization of large sets of candidate designs and then winnowing them down. We experimented with multidimensional scaling and then collective line graphs before settling on linked scatterplots to visualize performance in a design of up to 10 million antennas at a time. In the end, the scatterplot solution was most successful at balancing intelligibility with visualization of the space as a whole. The design allows for adding more 1D or 2D linked feature visualizations if needed, and it smoothly transitions to other "details on demand" views for final tweaking.

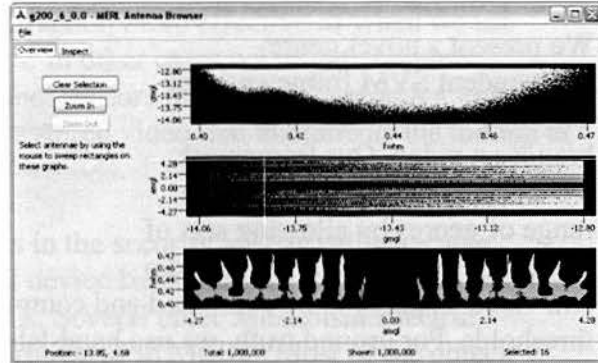

Speech Denoising Using Nonnegative Matrix Factorization with Priors

Citation: Wilson, K.W.; Raj, B.; Smaragdis, P.; Divakaran, A., "Speech Denoising Using Nonnegative Matrix Factorization with Priors," *IEEE International Conference on Acoustics, Speech and Signal Processing (ICASSP)*, ISSN: 1520-6149, pp. 4029-4032, March 2008

Contacts: Kevin W. Wilson, Bhiksha Raj

We present a technique for denoising speech using nonnegative matrix factorization (NMF) in combination with statistical speech and noise models. We compare our new technique to standard NMF and to a state-of-the-art Wiener filter implementation and show improvements in speech quality across a range of interfering noise types.

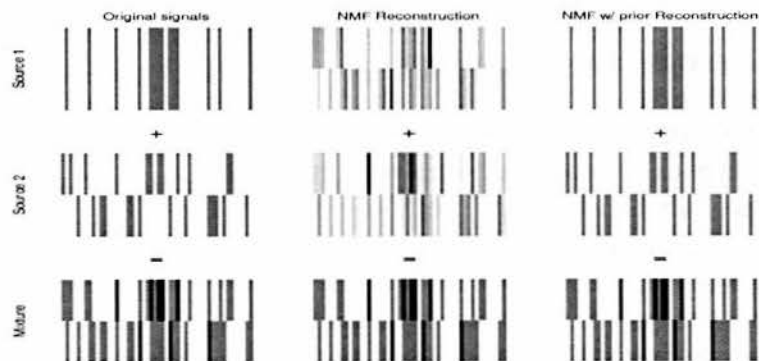

An SVM Framework for Genre-Independent Scene Change Detection

Citation: Goela, N.; Wilson, K.; Niu, F.; Divakaran, A.; Otsuka, I., "An SVM Framework for Genre-Independent Scene Change Detection," *IEEE International Conference on Multimedia and Expo (ICME)*, ISBN: 1-4244-1017-7, pp. 532-535, July 2007

Contacts: Kevin W. Wilson

We present a novel genre-independent SVM framework for detecting scene changes in broadcast video. Our framework works on content from a diverse range of genres by allowing sets of features, extracted from both audio and video streams, to be combined and compared automatically without the use of explicit thresholds. For ground truth, we use hand-labeled video scene boundaries from a wide variety of broadcast genres to generate positive and negative samples for the SVM. Our experiments include high-and low-level audio features such as semantic histograms and distances between Gaussian models, as well as video features such as shot cut positions. We evaluate the importance of these measures in a structured framework, with performance comparisons oriented via ROC curves. We achieve over 70% detection rate for 10% false positive rate on our corpus of over 7.5 hours of data collected from news, talk shows, sitcoms, dramas, music videos, and how-to-shows.

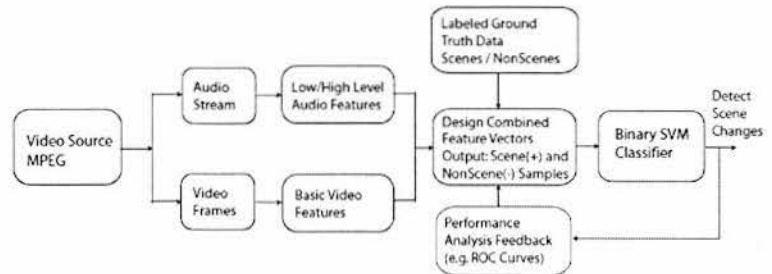

Assessment of End-User Response to Sports Highlights Extraction for Personal Video Recorders

Citation: Shubin, H.; Divakaran, A.; Wittenburg, K.; Peker, K.A.; Radhakrishnan, R., "Assessment of End-User Response to Sports Highlights Extraction for Personal Video Recorders," *SPIE Conference Multimedia Content Access Algorithms and Systems*, Vol. 6506, January 2007

Contacts: Kent Wittenburg

We tested our previously reported sports highlights playback for personal video recorders with a carefully chosen set of sports aficionados. Each subject spent about an hour with the content, going through the same basic steps of introduction, trying out the system, then completing a follow up questionnaire. The main conclusion was that the users unanimously liked the functionality even when it made mistakes. Furthermore, the users felt that if the user interface were made much more responsive so as to quickly compensate for false alarms and misses, the functionality would be vastly enhanced. The ability to choose summaries of any desired length turned out to be the main attraction.

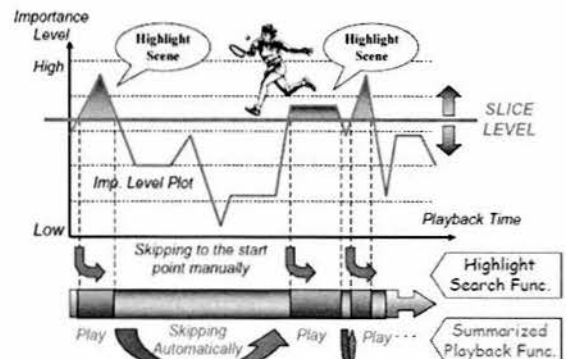

Imaging

The research in the Imaging group at MERL covers all aspects of extracting information from images. For instance, from a picture of a face we could calculate a numerical code for that face that would allow recognizing that person again in another picture. Or we could track a moving object in video to quantify its trajectory. In some cases we might modify the actual image creation process to make subsequent information extraction more effective as when we use multiple flash exposures to identify an object's edges. In other cases we might combine information from cameras with information from other sensors like when we search a historical database from a network of motion sensors to access stored video that documents the motion at the time and place specified.

For several years MERL has contributed to products in the security and surveillance area. Mitsubishi Electric has introduced an access control device based on the face detection and face recognition algorithms that were developed at MERL. Several other Mitsubishi Electric surveillance products use tracking algorithms that originated in MERL. Most of the object detection and tracking research heavily uses machine learning algorithms and image processing. Recently we have been getting more involved in the measurement of shape—a fundamental aspect of problems in robot vision and medical imaging. In the last year we also did research pushing the boundaries of camera image forming by introducing structure in the details of the camera exposure time or aperture, allowing recovery of richer image information.

Recent Research

Learning on Lie Groups for Invariant Detection and Tracking	54
Boosting Adaptive Linear Weak Classifiers for Online Learning and Tracking	54
Kernel Integral Images: A Framework for Fast non-Uniform Filtering	55
Non-Refractive Modulators for Encoding and Capturing Scene Appearance and Depth	55
Joint Tracking and Video Registration by Factorial Hidden Markov Models	56
Visualizing the History of Living Spaces	56
SocialMotion: Measuring the Hidden Social Life of a Building	57
Buzz: Measuring and Visualizing Conference Crowds	57
Dappled Photography: Mask Enhanced Cameras for Heterodyned Light Fields and Coded Aperture Refocusing	58
Factored Time-Lapse Video	58
Post-production Facial Performance Relighting using Reflectance Transfer	59
Prakash: Lighting Aware Motion Capture using Photosensing Markers and Multiplexed Illuminators	59
Seam Carving for Content-Aware Image Resizing	60

Learning on Lie Groups for Invariant Detection and Tracking

Citation: Tuzel, O.; Porikli, F.; Meer, P., "Learning on Lie Groups for Invariant Detection and Tracking", *IEEE Computer Society Conference on Computer Vision and Pattern Recognition (CVPR)*, ISSN: 1063-6919, June 2008

Contacts: Oncel Tuzel, Fatih Porikli



This paper presents a novel learning based tracking model combined with object detection. The existing technique proceeds by linearizing the motion, which makes an implicit Euclidean space assumption. Most of the transformations used in computer vision have a matrix Lie group structure. We learn the motion model on the Lie algebra and show that the formulation minimizes a first order approximation to the geodesic error. The learning model is extended to train a class-specific tracking function which is then integrated with an existing pose-dependent object detector to build a pose-invariant object detection algorithm. The proposed model can accurately detect objects in various poses where the size of the search space is only a fraction of that for existing object detection methods. The detection rate of the original detector is improved by more than 90% for large transformations.

Boosting Adaptive Linear Weak Classifiers for Online Learning and Tracking

Citation: Parag, T.; Porikli, F.; Elgammal, A., "Boosting Adaptive Linear Weak Classifiers for Online Learning and Tracking," *IEEE Conference on Computer Vision and Pattern Recognition (CVPR)*, ISSN: 1063-6919, pp. 1-8, June 2008

Contacts: Fatih Porikli

Online boosting methods have recently been used successfully for tracking, background subtraction, etc. Conventional online boosting algorithms emphasize interchanging new weak classifiers/features to adapt with the change over time. We are proposing an online boosting algorithm where the form of the weak classifiers themselves are modified to cope with scene changes.

Instead of replacement, the parameters of the weak classifiers are altered in accordance with the new data subset presented to the online boosting process at each time step. Thus we may avoid altogether the issue of how many weak classifiers should be replaced to capture the change in the data or which efficient search algorithm to use for a fast retrieval of weak classifiers. A computationally efficient method has been used in this paper for the adaptation of linear weak classifiers. The proposed algorithm has been implemented to be used both as an online learning and a tracking method. We show quantitative and qualitative results on both UCI datasets and several video sequences to demonstrate improved performance of our algorithm.

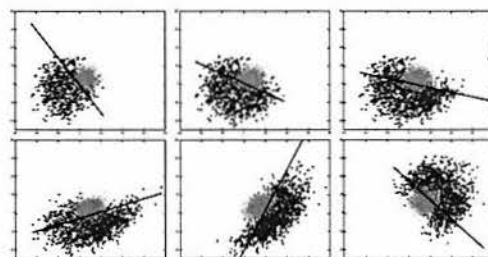

Kernel Integral Images: A Framework for Fast non-Uniform Filtering

Citation: Hussein, M.; Porikli, F.; Davis, L., "Kernel Integral Images: A Framework for Fast non-Uniform Filtering," *IEEE Conference on Computer Vision and Pattern Recognition (CVPR)*, ISSN: 1063-6919, pp. 1-8, June 2008

Contacts: Fatih Porikli

Integral images are commonly used in computer vision and computer graphics applications. Evaluation of box filters via integral images can be performed in constant time, regardless of the filter size. Although Heckbert extended the integral image approach for more complex filters, its usage has been very limited in practice. In this paper, we present an extension to integral images that allows for application of a wide class of non-uniform filters. Our approach is superior to Heckbert's in terms of precision requirements and suitability for parallelization. We explain the theoretical basis of the approach and instantiate two concrete examples: filtering with bilinear interpolation, and filtering with approximated Gaussian weighting. Our experiments show the significant speedups we achieve, and the higher accuracy of our approach.

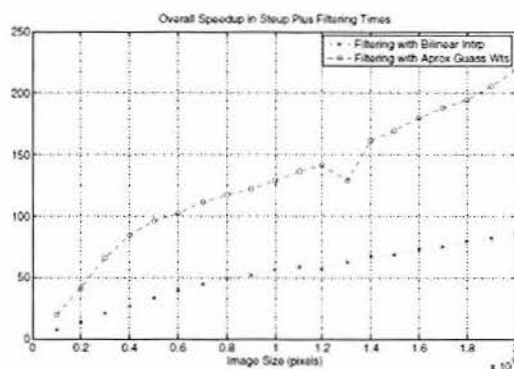

Non-Refractive Modulators for Encoding and Capturing Scene Appearance and Depth

Citation: Veeraraghavan, A.; Agrawal, A.; Raskar, R; Mohan, A.; Tumblin, J., "Non-Refractive Modulators for Encoding and Capturing Scene Appearance and Depth," *IEEE Computer Society Conference on Computer Vision and Pattern Recognition (CVPR)*, ISSN: 1063-6919, June 2008

Contacts: Ashok Veeraraghavan, Amit Agrawal

We analyze the modulation of a light field via non-refracting attenuators. In the most general case, any desired modulation can be achieved with attenuators having four degrees of freedom in ray-space. We motivate the discussion with a universal 4D ray modulator (ray-filter) which can attenuate the intensity of each ray independently. We describe operating such a fantasy ray-filter in the context of altering the 4D light field incident on a 2D camera sensor. Ray-filters are difficult to realize in practice but we can achieve reversible encoding for light field capture using a patterned attenuating mask. We analyze and extend two mask-based designs for optimal light field sampling by matching the modulation function to the specific shape of the band-limit frequency transform of the light field.

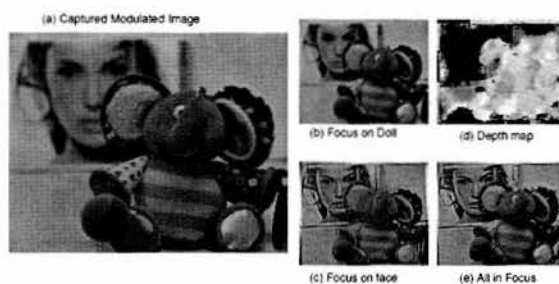

Joint Tracking and Video Registration by Factorial Hidden Markov Models

Citation: Mei, X.; Porikli, F., "Joint Tracking and Video Registration by Factorial Hidden Markov Models," *International Conference on Acoustic Speech and Signal Processing (ICASSP)*, ISSN: 1520-6149, pp. 973-976, March 2008

Contacts: Fatih Porikli

Tracking moving objects from image sequences obtained by a moving camera is a difficult problem since there exists apparent motion of the static background. It becomes more difficult when the camera motion between the consecutive frames is very large. Traditionally, registration is applied before tracking to compensate for the camera motion using parametric motion models. At the same

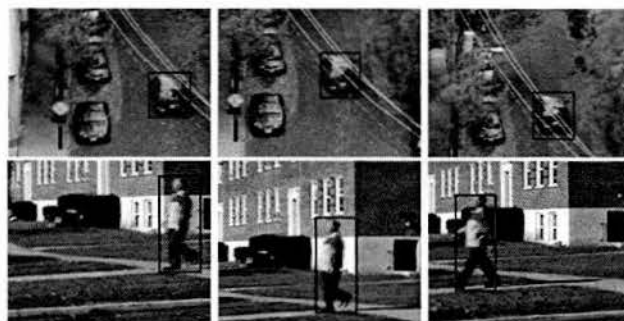

time, the tracking result greatly depends on registration performance. Problems arise when there are big moving objects in the scene and the registration algorithm is prone to fail since the tracker easily drifts away when poor registration results occur. In this paper, we address this problem by registering the frames and tracking the moving objects simultaneously within the factorial Hidden Markov Model framework using particle filters. We apply our algorithm to moving object tracking on numerous image sequences with camera motion and show the robustness and effectiveness of our method.

Visualizing the History of Living Spaces

Citation: Ivanov, Y.; Wren, C.; Sorokin, A.; Kaur, I., "Visualizing the History of Living Spaces," *IEEE Transactions on Visualization and Computer Graphics*, ISSN: 1077-2626, Vol. 13, Issue 6, pp. 1153-1160, December 2007

Contacts: Yuri Ivanov, Christopher R. Wren

The technology available to building designers now makes it possible to monitor buildings on a very large scale. Video cameras and motion sensors are commonplace in practically every office space, and are slowly making their way into living spaces. The application of such technologies, particularly video cameras, while improving security, also violates privacy. On the other hand, motion sensors, while being privacy-conscious, typically do not provide enough information for a human operator to maintain the same degree of awareness about the space that can

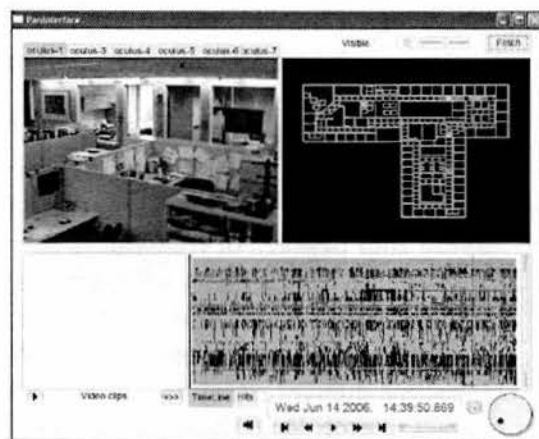

be achieved by using video cameras. We propose a novel approach using a large number of simple motion sensors and a small set of video cameras to monitor a large office space. In our system, we deployed 215 motion sensors and six video cameras to monitor the 3,000-square-meter office space occupied by 80 people for a period of about one year.

SocialMotion: Measuring the Hidden Social Life of a Building

Citation: Wren, C.; Ivanov, Y.; Kaur, I; Leigh, D.; Westhues, J., "SocialMotion: Measuring the Hidden Social Life of a Building," *Third International Symposium on Location- and Context-Awareness (LoCA 2007)*, ISBN: 978-3-540-75159-5, Volume 4718/2007, pp. 85-102, September 2007

Contacts: Christopher R. Wren, Yuri Ivanov

We present an approach to analyzing the social behaviors that occur in a typical office space. We describe a system consisting of over 200 motion sensors connected in a wireless network observing a medium-sized office space populated with almost 100 people for a period of almost a year. We use a tracklet graph representation of the data in the sensor network, which allows us to efficiently evaluate gross patterns of office-wide social behavior of its occupants during expected seasonal changes in the workforce as well as unexpected social events that affect the entire population of the space. We present our experiments with a method based on Kullback-Leibler metric applied to the office activity modelled as a Markov process. Using this approach we detect gross deviations of short term office-wide behavior patterns from previous long-term patterns spanning various time intervals. We compare detected deviations to the company calendar to find and provide some quantitative analysis of the relative impact of those disruptions across a range of temporal scales. We also present a favorable comparison to results achieved by applying the same analysis to email logs.

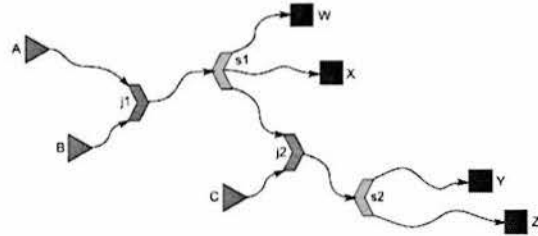

Buzz: Measuring and Visualizing Conference Crowds

Citation: Wren, C.R.; Ivanov, Y.A.; Leigh, D.; Westhues, J., "Buzz: Measuring and Visualizing Conference Crowds," *ACM SIGGRAPH, Emerging Technologies*, Article 25, August 2007

Contacts: Christopher R. Wren, Yuri Ivanov

This report is a proposal for an exhibition that will explore the idea of using technology to understand the movement of people. Not just on a small stage, but in an expansive environment. Not the fine details of movement of individuals, but the gross patterns of a population. Not the identifying biometrics, but the group behavioral patterns that evolve from the structure of the environment and the points of interest embedded in that structure. In this instance: a marketplace, and in particular, the marketplace of ideas called Emerging Technologies at SIGGRAPH 2007.

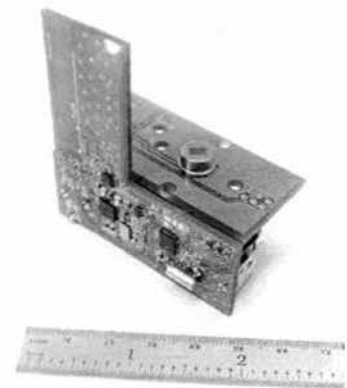

Dappled Photography: Mask Enhanced Cameras for Heterodyned Light Fields and Coded Aperture Refocusing

Citation: Veeraraghavan, A.; Raskar, R.; Agrawal, A.; Mohan, A.; Tumblin, J., "Dappled Photography: Mask Enhanced Cameras for Heterodyned Light Fields and Coded Aperture Refocusing," *ACM Transactions on Graphics (TOG)*, ISSN: 0730-0301, Vol. 26, Issue 3, Article 69, July 2007

Contacts: Ashok Veeraraghavan, Amit Agrawal

We describe a theoretical framework for reversibly modulating 4D light fields using an attenuating mask in the optical path of a lens based camera. Based on this framework, we present a novel design to reconstruct the 4D light field from a 2D camera image without any additional refractive elements as required by previous light field cameras. The patterned mask attenuates light rays inside the camera instead of bending them, and the attenuation recoverably encodes the rays on the 2D sensor. Our mask-equipped camera focuses just as a traditional camera to capture conventional 2D photos at full sensor resolution, but the raw pixel values also hold a modulated 4D light field. The light field can be recovered by rearranging the tiles of the 2D Fourier transform of sensor values into 4D planes and computing the inverse Fourier transform. In addition, one can also recover the full resolution image information for the in-focus parts of the scene.

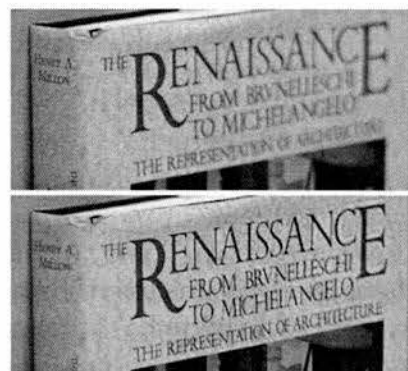

Factored Time-Lapse Video

Citation: Sunkavalli, K; Matusik, W.; Pfister, H.; Rusinkiewicz, S., "Factored Time-Lapse Video," *ACM Transactions on Graphics (TOG)*, ISSN:0730-0301, Vol. 26, Issue 3, Article 101, July 2007

Contacts: Jay Thornton



(a) Original

(b) Reconstructed, no shadows

(c) Sun illumination only

(d) Modified reflectance

We describe a method for converting time-lapse photography captured with outdoor cameras into Factored Time-Lapse Video (FTLV): a video in which time appears to move faster (i.e., lapsing) and where data at each pixel has been factored into shadow, illumination, and reflectance components. The factorization allows a user to easily relight the scene, recover a portion of the scene geometry (normals), and to perform advanced image editing operations. Our method is easy to implement, robust, and provides a compact representation with good reconstruction characteristics. We show results using several publicly available time-lapse sequences.

Post-production Facial Performance Relighting using Reflectance Transfer

Citation: Peers, P., Tamura, N.; Matusik, W.; Debevec, P., "Post-production Facial Performance Relighting using Reflectance Transfer," *ACM Transactions on Graphics (TOG)*, ISSN: 0730-0301, Vol. 26, Issue 3, Article 52, July 2007

Contacts: Jay Thornton

We propose a novel post-production facial performance relighting system for human actors. Our system uses just a dataset of view-dependent facial appearances with a neutral expression, captured for a static subject using a Light Stage apparatus. For the actual performance, however, a potentially different actor is captured under known, but static, illumination. During

post-production, the reflectance field of the reference dataset actor is transferred onto the dynamic performance, enabling image-based relighting of the entire sequence. Our approach makes post-production relighting more practical and could easily be incorporated in a traditional production pipeline since it does not require additional hardware during principal photography. Additionally, we show that our system is suitable for real-time post-production illumination editing.

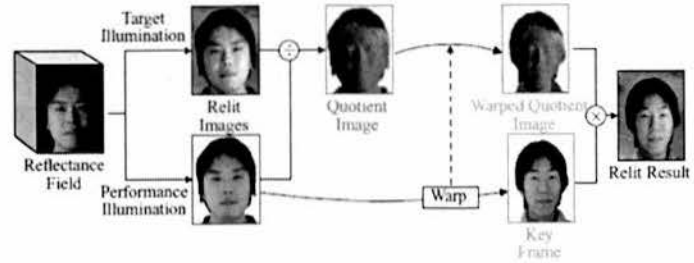

Prakash: Lighting Aware Motion Capture using Photosensing Markers and Multiplexed Illuminators

Citation: Raskar, R.; Nii, H.; deDecker, B.; Hashimoto, Y.; Summet, J.; Moore, D.; Zhao, Y.; Westhues, J.; Dietz, P.; Barnwell, J.; Nayar, S.; Inami, M.; Bekaert, P.; Noland, M.; Branzoi, V.; Bruns, E., "Prakash: Lighting Aware Motion Capture using Photosensing Markers and Multiplexed Illuminators," *ACM Transactions on Graphics (TOG)*, ISSN: 0730-0301, Vol. 26, Issue 3, Article 36, July 2007

Contacts: Jay Thornton

In this paper, we present a high speed optical motion capture method that can measure three dimensional motion, orientation, and incident illumination at tagged points in a scene. We use tracking tags that work in natural lighting conditions and can be imperceptibly embedded in attire or other objects. Our system supports an unlimited number of tags in a scene, with each tag uniquely identified to eliminate marker reacquisition issues. Our tags also provide incident illumination data which can be used to match scene lighting when inserting synthetic elements. The technique is therefore ideal for on-set motion capture or real-time broadcasting of virtual sets.



Seam Carving for Content-Aware Image Resizing

Citation: Avidan, S.; Shamir, A., "Seam Carving for Content-Aware Image Resizing," *ACM Transactions on Graphics (TOG)*, ISSN:0730-0301, Vol. 26, Issue 3, Article 10, July 2007

Contacts: Jay Thornton

Effective resizing of images should not only use geometric constraints, but consider the image content as well. We present a simple image operator called seam carving that supports content-aware image resizing for both reduction and expansion. A seam is an optimal 8-connected path of pixels on a single image from top to bottom, or left to right, where optimality is defined by an image energy function. By repeatedly carving out or inserting seams in one direction we can change the aspect ratio of an image. By applying these operators in both directions we can retarget the image to a new size. The selection and order of seams protect the content of the image, as defined by the energy function. Seam carving can also be used for image content enhancement and object removal. We support various visual saliency measures for defining the energy of an image, and can also include user input to guide the process. By storing the order of seams in an image we create multi-size images, that are able to continuously change in real time to fit a given size.



Mechatronics

The Mechatronics group conducts research, development and generation of state-of-the-art theory and technology in the areas of mechatronics design and control, merging advanced control theory, mechanical and materials engineering, optics, signal and power electronics, physics, and thermodynamics, all aiming to expand the performance envelope of mechatronic technology.

The Mechatronics group also pursues the advancement and improvement of MELCO's products that utilize mechatronics and control technologies, and develop advanced technologies and tools for simulation and visualization of related processes. MERL researchers are collaborating closely with MELCO's mechatronics and control R&D facilities in Japan.

The motivations for this R&D program are twofold. First, the design and control of electromechanical devices is central to many areas of MELCO's business, such as factory automation and transportation (automotive, elevator, and escalator). Second, with the rapidly increasing power of embedded computation in electromechanical systems, we felt there was the opportunity for synergy between research in mechatronics and control and MERL's existing research strengths in computer and information technology.

The Mechatronics group was started at MERL during the term of this report. As a result, research is just getting underway and there isn't any completed work to describe in this report.

Algorithms

The Algorithms group at MERL develops solution methods for optimization problems involving very large numbers of variables. Typically these arise in inference problems involving images, video, or audio; network transport problems; coding and compression problems; or design problems. Usually these problems are characterized by very complicated probability distributions in extremely high dimensional spaces. Because classical approaches to these problems are infeasible, our results can open new business opportunities where there are no competitive technologies.

Most of the group's work revolves around graph-based optimizations and inference, where the graph is a representation of the problem constraints and a probability distribution over possible solutions. Through formal analysis we identify tractable estimation or approximation schemes. This meshes with MERL's expertise in fields and technologies such as belief propagation, machine learning, computer vision, dynamic programming, convex optimization, coding and communications theory, and signal processing.

Recent Research

A Conditional Random Field for Automatic Photo Editing.....	64
Feature Transformation of Biometric Templates for Secure Biometric Systems based on Error Correcting Codes.....	64
Routing in Cooperative Wireless Networks with Mutual-Information Accumulation.....	65
Iterative Linear-Programming-Based Route Optimization for Cooperative Networks.....	65
Performance of Fountain Codes in Collaborative Relay Networks.....	66
Low-Latency Decoding of EG LDPC Codes.....	66
Highly Accurate DSM Reconstruction Using Ku-band Airborne InSAR.....	67
Stochastic Shortest Paths Via Quasi-convex Maximization.....	67
Optimal Route Planning under Uncertainty.....	68
Fast Low-Rank Modifications of the Thin Singular Value Decomposition.....	68

A Conditional Random Field for Automatic Photo Editing

Citation: Brand, M.; Pletscher, P., "A Conditional Random Field for Automatic Photo Editing," *IEEE Conference on Computer Vision and Pattern Recognition (CVPR)*, ISSN 1063-6919, pp. 1-7, June 2008

Contacts: Matthew Brand

We introduce a method for fully automatic touch-up of face images by making inferences about the structure of the scene and undesirable textures in the image. A distribution over image segmentations and labelings is computed via a conditional random field; this distribution controls the application of various local image transforms to regions in the image. Parameters governing both the labeling and transforms are jointly optimized w.r.t. a training set of before-and-after example images.

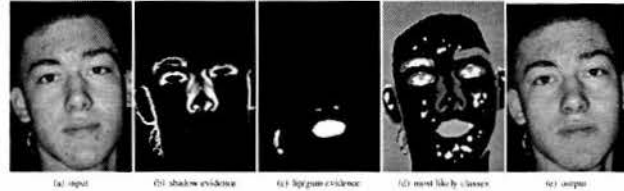

One major advantage of our formulation is the ability to marginalize over all possible labeling and thus exploit all the information in the distribution; this yield better results than MAP inference. We demonstrate with a system that is trained to correct red-eye, reduce specularities, and remove acne and other blemishes from faces, showing results with test images scavenged from acne-themed internet message boards.

Feature Transformation of Biometric Templates for Secure Biometric Systems based on Error Correcting Codes

Citation: Sutcu, Y.; Rane, S.; Yedidia, J.S.; Draper, S.C.; Vetro, A., "Feature Transformation of Biometric Templates for Secure Biometric Systems based on Error Correcting Codes," *IEEE Computer Society Conference on Computer Vision and Pattern Recognition (CVPR)*, ISSN 1063-6919, June 2008

Contacts: Shantanu Rane, Anthony Vetro, Jonathan Yedidia

Secure storage of biometric templates is extremely important because a compromised biometric cannot be revoked and replaced an unlimited number of times. In many approaches proposed for secure biometric storage, an error correcting code (ECC) is applied to the enrollment biometric and the resulting parity or syndrome symbols are stored on the access control device, instead of the original biometric. The principal challenge here is that most standard ECCs are designed for memoryless channel statistics, whereas the variations between enrollment and probe biometrics have significant spatial correlation. To address this challenge, we propose to transform the original biometric into a feature vector that is explicitly matched to standard ECCs, thereby improving the security-robustness tradeoff of the overall biometric system. As a concrete example, we transform fingerprint minutiae maps into feature vectors compatible with ECCs designed for a binary symmetric channel. We conduct a statistical analysis of these feature vectors and show how our feature transformation algorithm may be combined with Low-Density Parity Check (LDPC) codes to obtain a secure fingerprint biometric system.

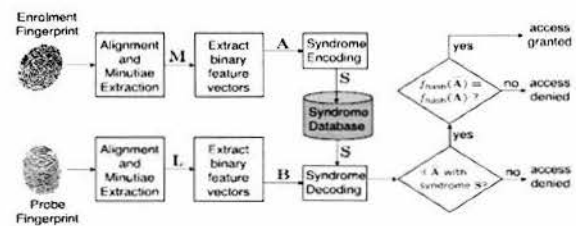

Routing in Cooperative Wireless Networks with Mutual-Information Accumulation

Citation: Draper, S.C.; Liu, A.; Molisch, A.F.; Yedidia, J.S., "Routing in Cooperative Wireless Networks with Mutual-Information Accumulation," *IEEE International Conference on Communications (ICC)*, ISBN: 978-1-4244-2075-9, pp. 4272-4277, May 2008

Contacts: Jonathan Yedidia

Cooperation between the nodes of wireless multihop networks can increase communication reliability, reduce energy consumption, and decrease latency. The possible improvements are even greater when nodes perform mutual-information accumulation, e.g., by using rateless codes. In this paper, we investigate routing problems in such networks.

Given a network, a source and a destination, our objective is to minimize end-to-end transmission delay under a sum energy constraint. We provide an algorithm that determines which nodes should participate in forwarding the message and what resources (time, energy, bandwidth) should be allocated to each. Our approach factors into two sub-problems, each of which can be solved efficiently. For any node decoding order we show that solving for the optimum resource allocation can be formulated as a linear problem. We then show that the decoding order can be improved systematically by swapping nodes based on the solution of the linear program.

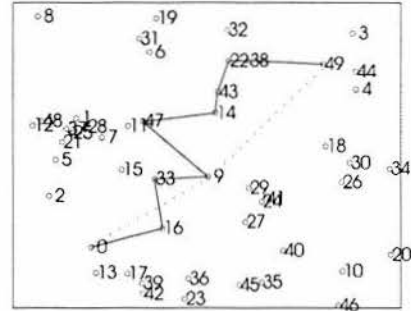

Iterative Linear-Programming-Based Route Optimization for Cooperative Networks

Citation: Draper, S.; Liu, L.; Molisch, A.; Yedidia, J., "Iterative Linear-Programming-Based Route Optimization for Cooperative Networks," *IEEE International Zurich Seminar on Communications*, ISBN: 978-1-4244-1682-0, pp. 84-87, March 2008

Contacts: Jonathan Yedidia

We develop linear-programming (LP) based route optimization techniques for networks of relays that employ mutual-information accumulation at the physical layer. Motivated by applications to unicast transmission in ultra wideband communications we concentrate on the regime where each node has a fixed bandwidth and transmission power. Our goal is to find the cooperative route that minimizes the source-to-destination transmission duration

subject to a sum-energy constraint. We address this by solving a sequence of LP-based route optimizations under increasingly tight energy constraints, revealing a trade-off between energy consumption and delay. An initial route is found by "flooding" the network, resulting in the smallest delay but largest energy consumption. Successive routes are found by initializing the LP with the optimum route found at the (slightly higher) previous energy constraint. Through this iterative procedure we explore a massive parameter space to find locally (and often globally) optimum solutions very efficiently.

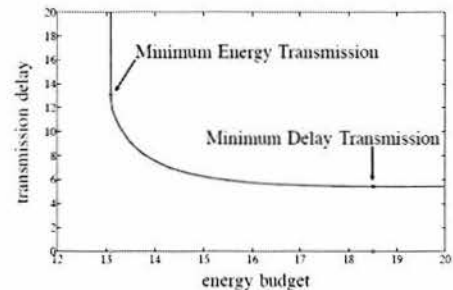

Performance of Fountain Codes in Collaborative Relay Networks

Citation: Molisch, A.F.; Mehta, N.B.; Yedidia, J.S.; Zhang, J., "Performance of Fountain Codes in Collaborative Relay Networks," *IEEE Transactions on Wireless Communications*, ISSN: 1536-1276, Vol. 6, Iss. 11, pp. 4108-4119, November 2007

Contacts: Jonathan Yedidia, Jinyun Zhang

Cooperative communications, where parallel relays forward information to a destination node, can greatly improve the energy efficiency and latency in ad-hoc networks. In this paper, we show that the concept of mutual-information-accumulation can be realized with the help of fountain codes, and leads to a lower energy expenditure and a lower transmission time than energy accumulation. We then provide an analysis of the

performance of mutual information accumulation in relay networks with N relay nodes. We first analyze the quasi-synchronous scenario where the source stops transmitting and the relay nodes start transmitting after L relay nodes have successfully decoded the source data. We show that an optimum L exists and is typically on the order of 3 or 4. We also give closed-form equations for the energy savings that can be achieved by the use of mutual-information-accumulation at the receiver. We then analyze and provide bounds for an alternate scenario where each relay node starts its transmission to the destination as soon as it has decoded the source data, independent of the state of the other relay nodes.

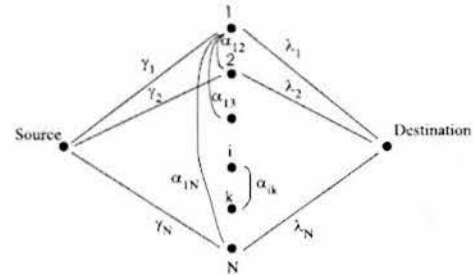

Low-Latency Decoding of EG LDPC Codes

Citation: Zhang, J.; Yedidia, J.S.; Fossorier, M.P.C., "Low-Latency Decoding of EG LDPC Codes," *Journal of Lightwave Technology*, Volume 25, Issue 9, pp. 2879-2886, September 2007

Contacts: Jonathan Yedidia

We describe simple iterative decodes for low-density parity-check codes based on Euclidean geometries, suitable for practical very-large-scale-integration implementation in applications requiring very fast decoders. The decoders are based on shuffled and replica-shuffled versions of iterative bit-flipping (BF) and quantized weighted BF schemes. The proposed decoders converge faster and provide better ultimate performance than standard BF decoders. We present simulations that illustrate the performance versus complexity tradeoffs for these decoders. We can show in some cases through importance sampling that no significant error floor exists.

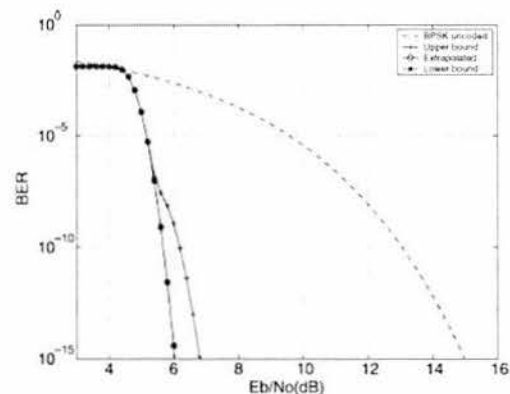

Highly Accurate DSM Reconstruction Using Ku-band Airborne InSAR

Citation: Okada, Y.; Hirao, C.; Horiuchi, T.; Hara, Y.; Yedidia, J.S.; Azarbayejani, A.; Oishi, N., "Highly Accurate DSM Reconstruction Using Ku-band Airborne InSAR," *IEEE International Geoscience and Remote Sensing Society Symposium (IGARSS)*, ISBN: 978-1-4244-1211-2, pp. 5049-5052, July 2007

Contacts: Jonathan Yedidia, Ali Azarbayejani

We present a newly developed airborne InSAR system incorporating a novel phase unwrapping algorithm, capable of retrieving a highly accurate Digital Surface Model (DSM). The SAR sensor system, with a spatial resolution of 30 cm, is carried on an airborne platform which has two antennas placed at a baseline length of 1 meter. We have established a DSM reconstruction processing technique, which includes the new "Iterated Conditional Modes-Minimum Cost Flow" (ICM-MCF)

phase-unwrapping algorithm. The ICM-MCF algorithm finds a locally optimal configuration of unwrapped phases under a well-characterized statistical model of the terrain and noise. An experimental field observation was carried out in Tsukuba, Japan. The DSM was generated, and the height accuracy of the SAR-DSM was evaluated by comparing with laser pro-filer data. For 50 cm X 50 cm mesh an accuracy of better than 50 cm in height was confirmed.

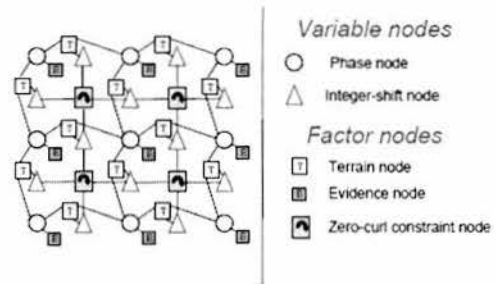

Stochastic Shortest Paths Via Quasi-convex Maximization

Citation: Nikolova, E.; Kelner, J.; Brand, M.; Mitzenmacher, M., "Stochastic Shortest Paths Via Quasi-convex Maximization," *ESA 2006*, ISBN:3-540-38875-3, pp. 552-563, September 2006

Contacts: Matthew Brand

We consider the problem of finding shortest paths in a graph with independent randomly distributed edge lengths. Our goal is to maximize the probability that the path length does not exceed a given threshold value (deadline). We give a surprising exact $n^{\Theta(\log n)}$ algorithm for the case of normally distributed edge lengths, which is based on quasi-convex maximization. We then prove average and smoothed polynomial bounds for this algorithm, which also translate to average and smoothed bounds for the parametric shortest path problem, and extend to a more general non-convex optimization setting. We also consider a number other edge length distributions, giving a range of exact and approximation schemes.

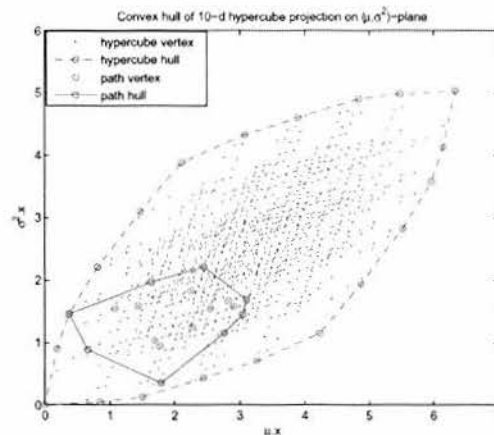

Optimal Route Planning under Uncertainty

Citation: Nikolova, E.; Brand, M.; Karger, D.R., "Optimal Route Planning under Uncertainty," *International Conference on Automated Planning and Scheduling (ICAPS)*, June 2006

Contacts: Matthew Brand

We present new complexity results and efficient algorithms for optimal route planning in the presence of uncertainty. We employ a decision theoretic framework for defining the optimal route: for a given source S and destination T in the graph, we seek an ST -path of lowest expected cost where the edge travel times are random variables and the cost is a nonlinear function of total travel time. Although this is a natural model for route-planning on real-world road networks, results are sparse due to the analytic difficulty of finding closed form expressions for the expected cost (Fan, Kalaba and Moore), as well as the computational/combinatorial difficulty of efficiently finding an optimal path which minimizes the expected cost. We identify a family of appropriate cost models and travel time distributions that are closed under convolution and physically valid. We obtain hardness results for routing problems with a given start time and cost functions with a global minimum, in a variety of deterministic and stochastic settings. In general the global cost is not separable into edge costs, precluding classic shortest-path approaches. However, using partial minimization techniques, we exhibit an efficient solution via dynamic programming with low polynomial complexity.

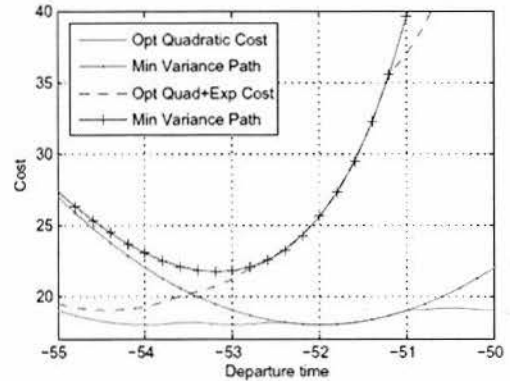

Fast Low-Rank Modifications of the Thin Singular Value Decomposition

Citation: Brand, M., "Fast Low-Rank Modifications of the Thin Singular Value Decomposition," *Linear Algebra and Its Applications*, Vol. 415, Issue 1, pp. 20-30, May 2006

Contacts: Matthew Brand

This paper develops an identity for additive modifications of a singular value decomposition (SVD) to reflect updates, downdates, shifts, and edits of the data matrix. This sets the stage for fast and memory-efficient sequential algorithms for tracking singular values and subspaces. In conjunction with a fast solution for the pseudo-inverse of a submatrix of an orthogonal matrix, we develop a scheme for computing a thin SVD of streaming data in a single pass with linear time complexity: A rank- r thin SVD of a $p \times q$ matrix can be computed in $O(pqr)$ time for $r \leq \sqrt{\min(p,q)}$.

