

**Mitsubishi Electric Research Laboratories (MERL)**

# **Annual Report**

**April 2012 through March 2013**

**TR2013-00**

(Published July 2013)

Welcome to Mitsubishi Electric Research Laboratories (MERL), the North American corporate R&D arm of Mitsubishi Electric Corporation. In this report, you will find descriptions of MERL and our projects.

This work may not be copied or reproduced in whole or in part for any commercial purpose. Permission to copy in whole or in part without payment of fee is granted for nonprofit educational and research purposes provided that all such whole or partial copies include the following: a notice that such copying is by permission of Mitsubishi Electric Research Laboratories; an acknowledgment of the authors and individual contributions to the work; and all applicable portions of the copyright notice. Copying, reproduction, or republishing for another purpose shall require a license with payment of fee to Mitsubishi Electric Research Laboratories. All rights reserved.

Copyright © Mitsubishi Electric Research Laboratories, 2013  
201 Broadway, Cambridge, Massachusetts 02139  
617.621.7500

**Production:**

Karen Dickie, Rhiannon Young, Richard C. Waters

# Table of Contents

- Mitsubishi Electric Research Laboratories .....1
- Awards and Commendations .....7
- Technical Staff .....9
- Publications .....23
- Research .....33
  - Digital Communications .....35
  - Multimedia .....43
  - Data Analytics .....51
  - Imaging .....59
  - Mechatronics .....67
  - Algorithms .....75



# Mitsubishi Electric Research Laboratories

Mitsubishi Electric Research Laboratories (MERL) is the North American subsidiary of the corporate research and development organization of Mitsubishi Electric Corporation. MERL conducts application-motivated basic research and advanced development in optimization, control and signal processing.

MERL's mission—our assignment from Mitsubishi Electric:

- Generating new technology and intellectual property in areas of importance to Mitsubishi Electric.
- Significantly impacting Mitsubishi Electric's business: using our technical expertise in partnership with organizations in Mitsubishi Electric to produce new and improved products in Mitsubishi Electric's main areas of business.

MERL's vision—our goal for ourselves:

- Being one of the world's premiere research laboratories, doing long-term fundamental research that advances the frontiers of technology and makes lasting impacts on the world.
- Being the prime source of technology for Mitsubishi Electric in our areas of expertise.

MERL's values—how we operate:

- Hiring very high quality researchers and supporting them strongly with a flexible work environment featuring teamwork both inside MERL and with our colleagues at Mitsubishi Electric.
- Participating in the world research community, publishing our work while maintaining the confidentiality of business information, and collaborating with interns and university researchers.

MERL focuses on five principal technology sectors:

Electronics & Communications - featuring wireless & optical signal processing technology.

Multimedia – featuring speech interfaces, video (de)coding & compressive sensing.

Data Analytics – featuring simulation, planning and optimization.

Spatial Analysis – featuring 3D imaging processing algorithms.

Mechatronics – featuring advanced control of electro-mechanical systems.

An Algorithms group supports all five sectors, developing fundamental algorithms.

This annual report is a snapshot of MERL's web site. For additional and updated information please visit "[www.merl.com](http://www.merl.com)".

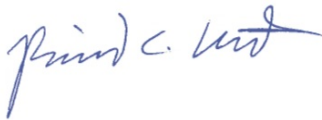

Richard C. Waters  
President, MERL

# MERL Organization

MERL is organized as six groups centered on technology areas, which collaborate closely to achieve groundbreaking results. We use a relatively flat organization to enhance the opportunities for collaboration within MERL. The five members of the top management team work closely together, guiding all aspects of MERL’s operation.

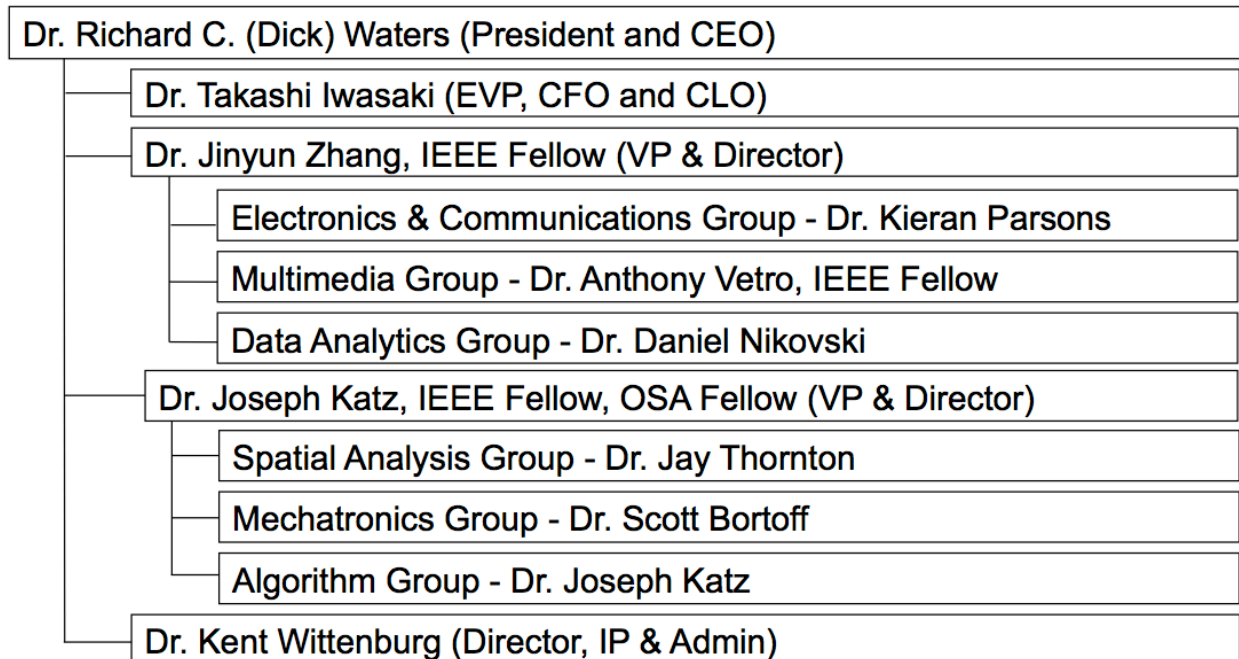

**Richard C. (Dick) Waters** *Ph.D., MIT, 1978*  
President, Chief Executive Officer & MERL Fellow

Dick Waters received his Ph.D. in artificial intelligence (AI). For the next 13 years he worked at the MIT AI Lab as a Research Scientist and co-principal investigator of the Programmer’s Apprentice project. Dick was a founding member of MERL’s Research Lab in 1991. As a MERL researcher, his work centered on multi-user interactive environments for work, learning, and play. For this work, he was made a MERL Fellow in 1996. In December 1999, he became CEO of MERL as a whole. Dick is an ACM Distinguished Scientist.



**Takashi Iwasaki** *Ph.D., Kyoto University, 1998*  
Executive Vice President, Chief Financial Officer & Chief Liaison Officer

Takashi Iwasaki joined Mitsubishi Electric's Industrial Electronics & Systems Laboratory in 1983 where he developed control technology for CNC, servo, robot, elevator, and other equipment. He moved to the Factory Automation Business Unit's Nagoya works in 2001. He transferred to the Advanced Technology R&D Center in 2006 where he rose to Senior Manager of the Mechanical Systems Department, before coming to MERL in 2012.



**Joseph Katz** *Ph.D., California Institute of Technology, 1981*  
Vice President & Director, IEEE Fellow, OSA Fellow

After leading research in optical communications and optoelectronic devices and materials at Caltech's Jet Propulsion Laboratory for a number of years, Joseph Katz went to Symbol Technologies, where as Senior VP of R&D he participated in, initiated, and led projects in a wide range of technologies, including barcode/RFID data capture, optics, imaging, signal processing, computing, networking, security, biometrics, and communications. He is a Fellow of the IEEE and the Optical Society of America, and holds more than 130 US patents. He joined MERL's management in 2004.



**Jinyun Zhang** *Ph.D., University of Ottawa, 1991*  
Vice President, Director & MERL Fellow, IEEE Fellow

Before joining MERL in 2001, Jinyun worked for Nortel Networks for 10 years where she held engineering and management positions in the areas of VLSI design and advanced wireless & optical technology development. She joined MERL's management in 2001. In recognition of her contributions to broadband wireless transmission and networking technology she became an IEEE Fellow in 2008.



**Kent Wittenburg** *Ph.D., University of Texas at Austin, 1986*  
Director Intellectual Property & Administration

Kent manages MERL's intellectual property activities and the admin group. He was formerly a lab Director at MERL for 9 years. Prior to joining MERL, he held positions at the Microelectronics and Computer Technology Corporation (MCC), Bellcore and Verizon/GTE Laboratories. His research interests have included natural language processing, multimodal interfaces, visual languages, and information visualization. He is a Senior member of the ACM.

# Mitsubishi Electric

One of the world's largest companies, Mitsubishi Electric Corporation has \$37 billion in annual sales, \$1.6 billion in operating profits (in the difficult year ending in March 2013) and more than 100,000 employees around the world (see [www.mitsubishielectric.com](http://www.mitsubishielectric.com)).

Mitsubishi Electric is composed of a wide range of operations. The primary business units are listed below.

<b>Mitsubishi Electric Corp.</b>
<b>Information Systems &amp; Network Services</b> IT Systems, Information Security/Encryption Systems, Business Solutions
<b>Public Utility Systems</b> Government Systems, Transportation Systems, Very Large Display Devices
<b>Energy &amp; Industrial Systems</b> Electrical Generators, Power Transmission and Distribution Equipment
<b>Building Systems</b> Elevators, Escalators, Building Monitoring/Security/Management Systems
<b>Electronic Systems</b> Satellites, Radar Systems, Antennas, Electronic Toll Collection Systems
<b>Communication Systems</b> Wired & Wireless Communication, Broadcasting Equipment and Systems
<b>Living Environment &amp; Digital Media Equipment</b> Televisions, Blu-ray Recorders, Air Conditioners, Solar Power Systems
<b>Factory Automation Systems</b> Programmable Logic Controllers, Inverters, Servo-motors, Processing Machines
<b>Automotive Equipment</b> Automotive Electrical Equipment, Car Electronics/Multimedia, Car Mechatronics
<b>Semiconductor &amp; Device</b> Optical Devices, High-Frequency & High-Power Semiconductors

Together, these ten business units produce most of Mitsubishi Electric's revenue. Due to the wide applicability of MERL's research, MERL works with them all.

It is worthy of note that there are over 30 major independent companies in the world that use the word "Mitsubishi" in their names. These companies include Mitsubishi UFJ Financial Group, Mitsubishi Corporation, Mitsubishi Heavy Industries, Mitsubishi Chemical Holdings and Mitsubishi Motors, all of which are also among the world's largest companies. They have shared roots in 19th century Japan; however, they have been separate for many years and Mitsubishi Electric has been separate from all of them since its founding in 1921.



# Mitsubishi Electric’s US Operations

A significant part of Mitsubishi Electric’s sales are in North America and many of Mitsubishi Electric’s business units have North American subsidiaries. The largest US operations are listed below (see [www.mitsubishielectric-usa.com](http://www.mitsubishielectric-usa.com)).

<p><b>Mitsubishi Electric Automotive America, Inc.</b> (Detroit, Mason OH)          Alternators, Ignition Coils, Automotive Electronics</p>
<p><b>Mitsubishi Electric Power Products, Inc.</b> (Pittsburgh)          Power Transmission Products, Rail Transportation Systems</p>
<p><b>Mitsubishi Electric USA, Inc.</b> (Los Angeles &amp; other cities)          Air Conditioners, Elevators, Photovoltaic Panels, High Power Semiconductors</p>
<p><b>Mitsubishi Electric Visual Solutions America, Inc.</b> (Irvine CA)          Digital Projectors, Display Walls, Photo Printers</p>
<p><b>Mitsubishi Electric Automation, Inc.</b> (Chicago)          Factory Automation Equipment</p>

# Mitsubishi Electric Corporate R&D

Mitsubishi Electric has a global R&D network comprising five laboratories. The chart below summarizes the primary activities of these labs. MERL collaborates with all of these labs.

<b>Corporate R&amp;D Headquarters (Tokyo)</b>	
	<p><b>Advanced Technology R&amp;D Center</b> (Amagasaki &amp; Nagaokakyo, in greater Osaka)          Power Electronics, Electro-mechanical, Ecology, Energy, Materials, Devices, Systems and Imaging Technologies</p>
	<p><b>Information Technology R&amp;D Center</b> (Ofuna, in greater Tokyo)          Information, Communications, Multimedia, Electro-Optic and Microwave Technologies</p>
	<p><b>Industrial Design Center</b> (Ofuna, in greater Tokyo)          Product, Interface and Concept Design</p>
	<p><b>Mitsubishi Electric Research Laboratories, Inc.</b> (Cambridge, Massachusetts)          Communications, Multimedia, Data Analytics, Imaging and Mechatronics Technologies</p>
	<p><b>Mitsubishi Electric R&amp;D Centre Europe, B.V.</b> (Rennes, France &amp; Edinburgh, Scotland)          Communications, Energy &amp; Environmental Technologies</p>



## **Awards and Commendations**

The high caliber of MERL's research and researchers is evident in a variety of ways. Two are highlighted below. The first is the members of our staff that are Fellows of technical societies. The second is best paper awards received from outside organizations. Listed below are awards for the period of this Annual Report.

### **Current Technical Society Fellows**

Dr. Joseph Katz - Fellow, Institute of Electrical and Electronic Engineers  
Dr. Joseph Katz - Fellow, Optical Society of America  
Dr. Huifang Sun - Fellow, Institute of Electrical and Electronic Engineers  
Dr. Anthony Vetro - Fellow, Institute of Electrical and Electronic Engineers  
Dr. Jin Zhang - Fellow, Institute of Electrical and Electronic Engineers

### **Awards and Major Events**

M. Li, S. Rane and P. Boufounos, Quantized Embeddings of Scale-Invariant Image Features for Mobile Augmented Reality, IEEE International Workshop on Multimedia Signal Processing (MMSP 2012), Banff, Canada, September 2012 (best top 10% of papers award).

In March 2013 MERL's speech team demonstrated the best performance in the 2<sup>nd</sup> CHiME Challenge, which evaluates various state-of-the-art algorithms for speech separation and recognition under challenging conditions.

It is also worthy of note that MERL's Imaging group had 4 papers accepted to CVPR 2012 and 4 more to ECCV — two of the most selective and prestigious Computer Vision Conferences. These results make MERL one of the most highly represented research labs in the world at these conferences with output greater than labs that are much larger.



## Technical Staff

The most important assets of MERL are its people. The following pages present the capabilities and interests of MERL's technical staff members as of the end of the period of this report. Additional information about their work can be found in the publications list and the project descriptions in this report.



**Amit K. Agrawal** *Ph.D., University of Maryland, 2006*  
Principal Member Research Staff

Amit's research is focused on computer vision and computational photography with emphasis on developing novel cameras and algorithms for scene interpretation, and designing physics-based models for vision. He has co-authored more than 30 papers in computer vision and computer graphics conferences including ECCV, CVPR, ICCV, and SIGGRAPH.



**Luigi (Lou) Baccari** *B.S., University of Massachusetts of Lowell*  
Manager Computational & Network Services

Lou has 23 years of experience in the System and Network Administrations field. For the 6 years prior to joining MERL he worked at HP/Compaq's Cambridge Research Labs providing System and Network. Previous to that he worked for Force Computers, Lycos and Digital Equipment Corp. as Data Center Manger and in various System/Network Support roles.



**John C. Barnwell III**  
Member Research Staff

John is a former Software Engineer developing configuration and database systems for the aircraft manufacturing, food processing, large truck manufacturing, and computer manufacturing industries. His interests include CNC control systems, and mechanical and electrical design. His current work involves the design and creation of the mechanical and electrical systems in support of experiments in all areas of MERL's research.



**Mouhacine Benosman** *Ph.D., Ecole Centrale de Nantes, 2002*  
Principal Member Research Staff

Before coming to MERL in 2010, Mouhacine worked at universities in Rome, Italy, Reims, France and Glasgow, Scotland before spending 5 years as a Research Scientist with the Temasek Laboratories at the National University of Singapore. His research interests include modeling and control of flexible systems, non-linear robust and fault tolerant control, vibration suppression in industrial machines and multi-agent control with applications to smart-grid.



**Ghulam M. Bhatti** *Ph.D., Boston University, 1998*  
Principal Member Research Staff

Prior to joining MERL, Ghulam developed system software for medical devices and communication switches. At MERL, his interests include prototyping, localization, security, algorithms, and communication protocols. He is listed as one of the major contributors to the IEEE 802.15.4e standard.



**Scott A. Bortoff** *Ph.D., University of Illinois Urbana-Champaign, 1992*  
Mechatronics Group Manager

Scott's research interests are in applications of nonlinear and optimal control theory to motion control, path planning and process control problems. Before joining MERL in 2009, Scott led the Controls Group at the United Technology Research Center and previously was an Associate Professor at the University of Toronto.



**Petros T. Boufounos** *Sc.D., Massachusetts Institute of Technology, 2006*  
Principal Member Research Staff

After completing his doctoral studies, Petros joined Rice University as a Postdoctoral associate until Jan. 2009, when he joined MERL. Since joining MERL, Petros has contributed in areas such as high-speed video acquisition, ultrasonic imaging, and privacy-preserving secure embeddings. His interests include signal acquisition and processing, signal representations and compressive sensing. He is also a visiting scholar at Rice University and an Associate Editor of IEEE Signal Processing Letters.



**Matthew E. Brand** *Ph.D., Northwestern University, 1994*  
MERL Fellow

Brand develops and analyzes optimization algorithms for problems in logistics, control, perception, data-mining, and learning. Notable results include methods for parallel solution of quadratic programs, recomposing photos by re-arranging pixels, nonlinear dimensionality reduction, online singular value decomposition, 3D shape-from-video, and learning concise models of data. In addition to academic "best paper" awards, this work has garnered several industrial awards for commercialized technologies.



**Dirk Brinkman** *J.D., Suffolk University Law School, 1990*  
Senior Patent Counsel

Dirk's undergraduate and Masters work was in Medical Physics. Prior to joining MERL in 1998, he spent most of his career at Digital Equipment Corporation, first as an engineer and product manager in the Medical Systems Group and then as a Patent Attorney for Digital's Research Laboratories in Cambridge, MA and Palo Alto, CA.



**Daniel J. Burns** *Ph.D., Massachusetts Institute of Technology, 2010*  
Member Research Staff

At MIT, Dan developed mechanical designs and controllers for atomic force microscopes that image nano-scale features 1,000 times faster than commercially available instruments. Previously, Dan worked at the Commercial Aviation Systems division of Honeywell, and NASA's Goddard Space Flight Center. Currently, Dan works on control systems design and multi-physical modeling.



**Robert A. Cohen** *Ph.D., Rensselaer Polytechnic Institute, 2007*  
Principal Member Research Staff

Prior to getting his Ph.D., Bob worked for 11 years at Philips Research Labs in NY on HDTV, scalable video streaming, video surveillance, and VLSI rapid prototyping. His current research interests are video coding & communications, and video, image & signal processing. He is an active participant in video coding standards.



**Stefano Di Cairano** *Ph.D., Carnegie Mellon University, 2004*  
Principal Member Research Staff

Stefano's interests are model predictive control, constrained control, networked control systems, optimization algorithms, stochastic systems, and their applications to automotive, aerospace, logistics, and factory automation. Stefano is a member of the IEEE CSS Conference Editorial Board, and the Chair of the IEEE CSS Technical Committee on Automotive Controls.



**Chunjie Duan** *Ph.D., University of Colorado at Boulder, 2008*  
Senior Principal Member Research Staff

Prior to joining MERL, Chunjie worked for Alcatel, Qualcomm and Ericsson and other telecom companies for over 10 years. His research interests are in wireless and optical communications, digital signal processing and VLSI/CAD technology.



**Huseyin Erdim** *Ph.D., University of Connecticut Storrs, 2009*  
Member Research Staff

Huseyin's research interests include geometric modeling, computer graphics, geometric and physical modeling of manufacturing processes, robotics, manufacturing automation, and more generally, theoretical and computational tools for systematic design and manufacturing. At MERL, he is developing and implementing algorithms and applications enabling innovative approaches to engineering design, analysis and manufacturing.



**Alan W. Esenther** *M.Sc., Boston University, 1993*  
Principal Member Research Staff

Alan enjoys human-computer interaction (HCI) design, distributed software development, graphical user interfaces and Internet technologies. His work has focused on touch applications that support multiple concurrent users, rapid image presentation for video browsing, and instant co-browsing (lightweight real-time distributed collaboration using unmodified web browsers).



**Tyler W. Garaas** *Ph.D., University of Massachusetts Boston, 2009*  
Member Research Staff

Tyler's graduate work focused on neural simulation, human perception, high-performance computing, computer vision, and computer graphics. His current work focuses on software applications incorporating advanced algorithms in the areas of computational geometry, discrete and continuous optimization, and computer vision.



**Guy Gold**  
Systems & Network Administrator

Guy Has 12 years of experience with Computing and Networking systems, with special interest in Unix/Linux systems. Previous to working at MERL, Guy worked as a Web Farm admin at Sutra Inc (Airline ticketing systems), as an IT consultant, as Network operations tech at Presbyterian Healthcare services (NM), and for Bezeq's (Israel) core Business IP/VPN support center.



**Abraham M. Goldsmith** *M.S., Worcester Polytechnic Institute, 2008*  
Member Research Staff

At WPI, Abraham researched 3D ultrasound imaging, particularly the reconstruction of 3D volumes from sequences of 2D images. At MERL he has worked in areas ranging from wireless sensor networks to optical metrology and control. In addition to his research responsibilities, Abraham provides electrical and mechanical engineering support to the entire laboratory.



**Piyush Grover** *Ph.D., Virginia Polytechnic Institute & State Univ., 2010*  
Member Research Staff

Piyush works at the intersection of dynamical systems, mechanics and control. He is interested in applying geometric and statistical methods for exploiting structure in nonlinear dynamical systems. Areas of applications include low-fuel space mission design, chaotic mixing, model reduction of distributed systems and nonlinear estimation.





**Jianlin Guo** *Ph.D., University of Windsor, 1995*  
Senior Principal Member Research Staff

Jianlin worked at Waterloo Maple as a software developer before joining MERL in 1998. His primary research interests include reliable wireless networks, SmartGrid systems, vehicular communications, broadband wireless communications, and embedded systems.



**Sohrab Haghghat**, *Ph.D. University of Toronto, 2012*  
Visiting Member Research Staff

Sohrab's research interests are in the areas of robust optimal control, model predictive control, multidisciplinary design optimization, flight dynamics and control, and nonlinear structural dynamics. His doctoral research was focused on control and design optimization of highly flexible aeroservoelastic wings. Sohrab was the recipient of the 2010 Etkin Medal for research excellence in the field of atmospheric flight mechanics.



**Bret A. Harsham** *B.S., Massachusetts Institute of Technology*  
Principal Member Research Staff

Before joining MERL in 2001, Bret worked at Dragon Systems on handheld and automotive speech products. At MERL, he works on research projects in the area of speech and multimodal applications, with a focus on effectiveness and usability. Past research projects have included work on multi-user touch interfaces and the safety & usability of in-car speech applications.



**John R. Hershey** *Ph.D., University of California San Diego, 2004*  
Senior Principal Member Research Staff & Speech and Audio Team Leader

Before coming to MERL in 2010, Hershey was a researcher at IBM's Watson Research Center in New York, in the Speech Algorithms and Engines group, where he was team leader of the Noise Robustness project. He is now working on machine learning for signal enhancement and separation, speech recognition, language processing, and adaptive user interfaces.



**Frederick J. Igo, Jr.** *B.A., Le Moyne College, 1982*  
Senior Principal Member Research Staff

Fred's professional interests are in software development and its process. He joined MERL in 1985 and has worked on various software technologies, including Distributed Computing, Distributed OLTP, Message Queuing, Mobile Agents, Data Mining, ZigBee, reliable wireless protocols and web development. Prior to joining MERL Fred worked at IPL systems.



**Michael J. Jones** *Ph.D., Massachusetts Institute of Technology, 1997*  
Senior Principal Member Research Staff

Mike's main areas of interest are computer vision, machine learning and data mining. He has focused on algorithms for detecting and analyzing people in images and video including face detection and recognition and pedestrian detection. He is a co-inventor of the popular Viola-Jones face detection method. Mike has been awarded the Marr Prize at ICCV and the Longuet-Higgins Prize at CVPR.



**Tamas Kalmar-Nagy** *Ph.D. Cornell University, 2002*  
Principal Member Research Staff

Tamas' research interests are in the theory and applications of nonlinear systems. Before joining MERL in 2012, Tamas worked at the United Technologies Research Center and then was an Assistant Professor at Texas A&M University. Tamas received a National Science Foundation CAREER award in 2009.



**Kyeong Jin Kim** *Ph.D., University of California Santa Barbara, 2000*  
Senior Principal Member Research Staff

Kyeong Jin's research interests include transceiver design, performance analysis of spectrum sharing systems, design of cooperative communication systems. Since joining MERL, he has contributed in areas such as reliable communications and E-WLAN system. Currently he is an Associate Editor of IEEE Communications Letters.



**Andrew Knyazev** *Ph.D., Inst of Numerical Math, Soviet Acad of Sci, 1985*  
Distinguished Member Research Staff

During his 30 years in the academy, Andrew contributed to numerical analysis of partial differential equations and computational linear algebra, with emphasis on eigenvalue problems. His focus at MERL is on novel algorithms for image & video processing, data analytics, data transmission, and model predictive control.



**Toshiaki Koike-Akino** *Ph.D., Kyoto University, 2005*  
Principle Member Research Staff

Prior to joining MERL in 2010, Toshiaki was a postdoctoral researcher at Harvard University. His research interests include signal processing, cooperative communications, coding theory, and information theory. He received best paper awards at IEEE GLOBECOM in 2008 and 2009.



**Keisuke Kojima** *Ph.D., University of Tokyo, 1990*  
*Senior Principal Member Research Staff*

During his 8 years at the Central Research Laboratory, Mitsubishi Electric Corp. (Amagasaki, Japan), and 13 years AT&T/Lucent Bell Laboratories and other major US companies, Keisuke worked on R&D of semiconductor lasers and optical systems as a technical staff and later as a manager. At MERL he is currently working on simulations of optical devices and systems. He has more than 100 publications in journals and conference proceedings.



**Christopher Laughman** *Ph.D., Massachusetts Institute Technology, 2008*  
*Member Research Staff*

Christopher's interests lie in the intersection of the modeling of physical systems and the experimental construction and testing of these systems, including simulation, numerical methods, and fault detection. He has worked on a variety of multi-physical systems, such as thermo-fluid systems and electromechanical energy conversion systems.



**Jonathan Le Roux** *Ph.D., University of Tokyo, 2009*  
*Member Research Staff*

Jonathan completed his B.Sc. and M.Sc. in Mathematics at the Ecole Normale Supérieure in Paris, France. Before joining MERL in 2011, he spent several years in Beijing and Tokyo. In Tokyo he worked as a postdoctoral researcher at NTT's Communication Science Laboratories. His research interests are in signal processing and machine learning applied to speech and audio.



**Feng Li** *Ph.D., University of Delaware, 2011*  
*Adjunct Member Research Staff*

Feng worked as a technical marketing engineer at Intel China before studying at UD for his Ph.D. His research interests are image/video enhancement (denoising, de-blurring, super-resolution), multi-camera system design and applications, and fluid surface reconstruction.



**Dehong Liu** *Ph.D., Tsinghua University, 2002*  
*Member Research Staff*

Prior to joining MERL in 2010, Dehong worked at Duke University as a post-doctoral Research Associate (2003-2008), Research Scientist (2008-2010) and Sr. Research Scientist (2010). His main research interests include compressive sensing, signal processing and machine learning.



**Ming-Yu Liu** *Ph.D., University of Maryland College Park, 2012*  
Adjunct Member Research Staff

Before joining MERL in 2012, Ming-Yu was a graduate research assistant in the computer vision research laboratory in University of Maryland. His dissertation was about discrete optimizations methods for segmentation and matching. His research interests are in computer vision and machine learning.



**Rui Ma** *Ph.D., University of Kassel, 2009,*  
Adjunct Member Research Staff

Prior to joining MERL, Rui was a Senior Power Amplifier Research Engineer at Nokia Siemens Networks. His research interests include RF Power Device Modeling, Power Amplifier / Radio Front-End Architectures, non-linear microwave circuit design and high frequency measurement techniques.



**Hassan Mansour**, *Ph.D. University of British Columbia, 2009*  
Member Research Staff

Hassan's research interests are in the areas of video compression, video transmission and compressed sensing. His PhD research developed resource allocation schemes for the transmission of scalable video content over bandwidth constrained wireless networks. His postdoctoral work developed adaptive sparse recovery algorithms for correlated signals from compressive measurements.



**Tim K. Marks** *Ph.D., University of California San Diego, 2006*  
Member Research Staff

Prior to joining MERL's Imaging Group in 2008, Tim did postdoctoral research in robotic Simultaneous Localization and Mapping in collaboration with NASA's Jet Propulsion Laboratory. His research at MERL spans a variety of areas in computer vision and machine learning, including face recognition under variations in pose and lighting, and robotic vision and touch-based registration for industrial automation.



**David Millar** *Ph.D., University College London (UCL), 2011*  
Adjunct Member Research Staff

Before joining MERL, David was a postdoctoral researcher at UCL, working on DSPs for coherent optical fiber transmission. Since then, he has been working on next generation systems and subsystems for the physical layer. He is particularly interested in advanced modulation formats, algorithms for equalization & carrier recovery, and reduced complexity transponders.



**Daniel N. Nikovski** *Ph.D., Carnegie Mellon University, 2002*  
Data Analytics Group Manager

Dan's research is focused on algorithms for reasoning, planning, and learning with probabilistic models. His current work is on the application of such algorithms to hard transportation problems such as group elevator control and traffic prediction. He also has varied interests in the field of data mining.



**Philip V. Orlik** *Ph.D., State University of New York at Stony Brook, 1999*  
Senior Principal Member Research Staff & Mobile Systems Team Leader

Prior to joining MERL in 2000, Phil worked as a simulation engineer for the MITRE Corporation. His current research interests include wireless communications and networking, signal processing for communication systems, queuing theory, and analytical modeling.



**Kieran Parsons** *Ph.D., University of Bristol, UK, 1996*  
Digital Communications Group Manager

Kieran spent 12 years in Canada working at Nortel, BelAir Networks and AMCC on the system design of several wireless and optical technologies, including early work on electronic dispersion compensation for optical links. His research interests include optical communications network architecture and digital signal processing algorithms for coherent optical communications.



**Ronald N. Perry** *B.Sc., Bucknell University, 1981*  
Distinguished Member Research Staff

Ron's fundamental research in computer graphics has resulted in numerous publications, a comprehensive patent portfolio, and the development of several meticulously crafted software and hardware products. Ron is best known for the Saffron Type System. The other highlight of his research is the development of 3D ADFs for CAD related products, including an NC simulation system demonstrating unprecedented precision and compactness.



**Fatih M. Porikli** *Ph.D., New York University (NYU), 2002*  
Distinguished Member Research Staff

Fatih's work covers areas including computer vision, machine learning, video surveillance, optimization, differential geometry, sparse reconstruction, biomedical vision, and online learning. with 110 publications and 60 granted US patents. He mentored more than 45 PhD students. He has received 3 IEEE Best Paper Awards and 5 Professional Prizes. He serves as an Associate Editor for 5 IEEE, Springer, and SIAM journals.



**Arvind Raghunathan** *Ph.D., Carnegie Mellon University, 2004*  
Principal Member Research Staff

Arvind's research focuses on algorithms for optimization of large-scale nonlinear and mixed integer nonlinear programs with applications in power grid, transportation systems and model-based control of processes. He previously worked at the United Technologies Research Center for 7 years developing optimization algorithms for aerospace, elevator, energy systems and security businesses.



**Srikumar Ramalingam** *Ph.D., INRIA Alpes, 2007*  
Principal Member Research Staff

Srikumar's PhD thesis on generic imaging models received the INPG best thesis prize and the AFRIF thesis prize (honorable mention) from the French Association for Pattern Recognition. His research interests include multi-view geometry and discrete optimization. At MERL, he has been working on robotics and car-navigation projects.



**Shantanu Rane** *Ph.D., Stanford University, 2007*  
Principal Member Research Staff

Shantanu's research interests are in the broad areas of signal processing and information theory. He is currently working on projects involving distributed source coding, secure biometrics, secure multiparty computation and visual inference.



**Zafer Sahinoglu** *Ph.D., New Jersey Institute of Technology, 2001*  
Senior Principal Member Research Staff

Zafer's research interests include real time space-time adaptive processing, remote sensing, anomaly detection in power grid systems, battery modeling, robust optimization, and data mining. He participates in ANSI and NIST smart-grid standards activities. Also, he is currently pursuing an MBA at MIT Sloan School of Management.



**Alan Sullivan** *Ph.D., University of California at Berkeley, 1993*  
Distinguished Member Research Staff

First at U.C. Berkeley, then at Lawrence Livermore National Laboratory, Alan studied interactions between ultra-high intensity femtosecond lasers and plasmas. Prior to joining MERL in 2007, he worked at a series of start-ups where he developed a novel volumetric 3D display technology. At MERL His research interests include computational geometry and computer graphics.



**Hongbo Sun** *Ph.D., Chongqing University, 1991*  
Principal Member Research Staff

Prior to joining MERL in 2010, Hongbo was a principal applications Engineer at Oracle, and a technical architect at SPL WorldGroup. He is a registered Professional Engineer and has more than 20 years' experience in technical consulting, product development and research on electrical transmission and distribution system planning, analysis, operation, and automation.



**Huifang Sun** *Ph.D., University of Ottawa, 1986*  
MERL Fellow / IEEE Fellow

After four years as a Professor at Fairleigh Dickinson University, Huifang moved to the Sarnoff Research Laboratory in 1990 becoming Technology Leader for Digital Video Communication. In 1995, Huifang joined MERL as the leader of MERL's video efforts. In recognition of his productive career in video processing, Huifang was made an IEEE Fellow in 2001.

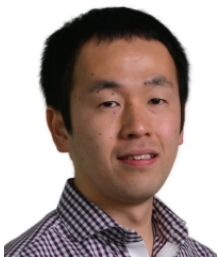

**Yuichi Taguchi** *Ph.D. The University of Tokyo, 2009*  
Member Research Staff

Yuichi worked on light field compression and conversion techniques for 3D TV during his Ph.D. After joining MERL in 2009, he has worked on algorithms and sensors for industrial robotics and catadioptric imaging. His current research interests include computational photography and 3D reconstruction.



**Koon Hoo Teo** *Ph.D., University of Alberta 1990*  
Senior Principal Member Research Staff & Power & Devices Team Leader

Koon Hoo was with Nortel for 15 years where he was actively involved in the research and implementation of 3G and 4G wireless systems. His work at MERL includes Cognitive Radio, Game Theory and Wireless Mesh for WiMAX and LTE systems. His current areas of research include Metamaterials, Power Amplifiers and Power Devices.



**Jay E. Thornton** *Ph.D., University of Michigan, 1982*  
Imaging Group Manager

Prior to joining MERL in 2002, Jay worked at Polaroid Corporation for many years on human vision and image science problems concerning color reproduction, image quality, half toning, and image processing. At MERL he has become absorbed in research on vision for robotics, medical imaging, computational photography, computer human observation, dictionary learning, and processing of the 3D world.



**Dong Tian** *Ph.D., Beijing University of Technology, 2001*  
Principal Member Research Staff

Dong has been working in the field of image/video compression and processing for over 10 years. He was deeply involved in the standardization of H.264/MPEG-4 AVC, and then worked for its extension Multiview Video Coding. After joining MERL in 2010, he has continued research in 3D video coding/processing and has been an active participant in the 3DV group.



**C. Oncel Tuzel** *Ph.D., Rutgers University, 2008*  
Principal Member Research Staff

Prior to his graduate studies, Oncel worked for 4 years on 3D game and simulation development. His doctoral work focused on statistical learning techniques on smooth manifolds and their applications to scene analysis. His research interests are in computer vision, machine learning, data mining, and computer graphics.



**Anthony Vetro** *Ph.D., Polytechnic University, 2001*  
Multimedia Group Manager / IEEE Fellow

Vetro joined MERL in 1996 and has been conducting research in the area of multimedia signal processing. He has contributed to the transfer and development of several technologies to digital television, surveillance, automotive, and satellite imaging systems. He has been an active participant in video coding standards and currently serves as Head of the US Delegation to MPEG.



**Gene V. Vinokur** *J.D., Suffolk University Law School, 2011*  
Patent Counsel

Gene graduated cum laude with distinction in Intellectual Property law. In addition, he holds advanced degrees in Mechanical Engineering and Computer Science. He is a member of Massachusetts Bar and has been a licensed patent practitioner since 2003.



**Bingnan Wang** *Ph.D., Iowa State University 2009*  
Member Research Staff

Bingnan's doctoral work focused on the study of wave propagation in novel electromagnetic materials, including photonic crystals and meta-materials. His research interests include electromagnetics and photonics, and their applications to communications, imaging, and energy systems.



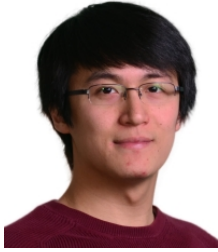

**Ye Wang** *Ph.D., Boston University, 2011*  
Visiting Member Research Staff

Ye was a member of the Information Systems and Sciences Laboratory at Boston University, where he studied information-theoretically secure multiparty computation. His current research interests include information security, biometric authentication, and data privacy.



**Yebin Wang** *Ph.D., University of Alberta, 2008*  
Member Research Staff

Prior to joining MERL, Yebin worked on process control, software development and management, and nonlinear estimation theory for over ten years. At MERL, Yebin has been working on control and estimation for various automation and transportation systems. Yebin's research interests include nonlinear estimation/control theory and applications, optimal control, adaptive/learning systems, modeling and control of complex systems.



**Shinji Watanabe** *Ph.D., Waseda University, 2006*  
Principal Member Research Staff

Prior to joining MERL in 2012, Shinji was a research scientist at NTT Communication Science Laboratories in Japan for 10 years, working on Bayesian learning for speech recognition, speaker adaptation, and language modeling. His research interests include speech recognition, spoken language processing, and machine learning.



**William S. Yerazunis** *Ph.D., Rensselaer Polytechnic Institute, 1987*  
Senior Principal Member Research Staff & Hardware Team Leader

Bill has worked in numerous fields, including parallel computation, SETI, jet engine production, real-time signal processing, expert systems, pattern recognition, text classification, wireless power, and meta-materials. He is the author of the CRM114 spam filter, has appeared as a continuing character in educational science television, and was voted one of the 50 most important people in computer network security by Network World magazine.



**Yiming Zhao** *Ph.D., Georgia Institute of Technology, 2012*  
Adjunct Member Research Staff

Yiming's current research focuses on the modeling, simulation, and control of mechanical and thermal systems, real-time trajectory optimization, and motion control. Before joining MERL in 2012, he worked as a research assistant in the Dynamics and Control Systems Lab at Georgia Tech on numerical optimal control, aircraft landing trajectory optimization, and air traffic modeling & simulation.



## Publications

The following lists the major publications by members of the MERL staff during the period of this report. A publication is considered major if it appeared in a refereed journal, a refereed conference proceeding or some other significant publication such as a book.

Sugiura, K.; Muso, T.; Tsuru, K.; Nikovski, D.; Esenther, A.; Sun, H., “**Development of a System for Power Theft Detection Using Smart Meters**”, *National Convention of the Information Processing Society of Japan (IPSJ)*, March 2013, ([TR2013-014](#))

Boufounos, P.T.; Rane, S., “**Efficient Coding of Signal Distances Using Universal Quantized Embeddings**”, *Data Compression Conference (DCC)*, Session 7, March 2013, ([TR2013-009](#))

Wang, Y.; Draper, S.C.; Yedidia, J.S., “**Hierarchical and High-Girth QC LDPC Codes**”, *IEEE Transactions on Information Theory*, ISSN: 0018-9448, Vol. 59, Issue 7, pp. 4553-4583, March 2013, ([TR2013-011](#))

Millar, D.; Lavery, D.; Maher, R.; Thomsen, B.C.; Bayvel, P.; Savory, S.J., “**A Baud-Rate Sampled Coherent Transceiver with Digital Pulse Shaping and Interpolation**”, *Optical Fiber Communication Conference and Exposition and the National Fiber Optic Engineers Conference (OFC/NFOEC)*, ISBN: 978-1-4799-0457-0, pp. 1-3, March 2013, ([TR2013-010](#))

Deng, Y.; Teo, K.H.; Harley, R.G., “**Generalized DC-link Voltage Balancing Control Method for Multilevel Inverters**”, *IEEE Applied Power Electronics Conference and Exposition (APEC)*, ISSN: 1048-2334, pp. 1219-1225, March 2013, ([TR2013-005](#))

Vecharynski, E.; Knyazev, A.V., “**Absolute Value Preconditioning for Symmetric Indefinite Linear Systems**”, *SIAM Journal of Scientific Computing*, Vol. 35(2), pp. A696-A718, March 2013, ([TR2013-016](#))

Le Roux, J.; Vincent, E., “**Consistent Wiener Filtering for Audio Source Separation**”, *IEEE Signal Processing Letters*, DOI: 10.1109/LSP.2012.2225617, Vol. 20, No. 3, pp. 217-220, March 2013, ([TR2012-090](#))

Kojima, K.; Nishikawa, S.; Yagyū, E.; Yuan, W.; Wang, B.; Koike-Akino, T.; Parsons, K., “**An MMI-based Polarization Splitter using Patterned Metal and Angled Joint**”, *IEICE 2013/02 OCS/ OFT/ OPE*, March 2013, ([TR2013-012](#))

Bahmani, S.; Raj, B.; Boufounos, P.; “**Greedy Sparsity-Constrained Optimization**”, *Journal of Machine Learning Research (JMLR)*, Vol. 14, pp. 807-841, March 2013, ([TR2013-015](#))

Tai, Y-W; Chen, X.; Kim, S.; Kim, S.J.; Li, F.; Yang, J.; Yu, J.; Matsushita, Y.; Brown, M.S., “**Nonlinear Camera Response Functions and Image Deblurring: Theoretical Analysis and Practice**”, *IEEE Transactions on Pattern Analysis and Machine Intelligence*, ISSN: 0162-8828, Vol. PP, Issue 99, pp. 1, February 2013, ([TR2013-008](#))

Rane, S.; Boufounos, P.T., “**Privacy-Preserving Nearest Neighbor Methods: Comparing Signals without Revealing Them**”, *IEEE Signal Processing Magazine*, ISSN: 1053-5888, Vol. 30, Issue 2, pp. 18-28, March 2013, ([TR2013-004](#))

Wang, Y.; Ishwar, P.; Rane, S., “**Information-Theoretically Secure Three-Party Computation with One Corrupted Party**”, *Cornell University Library*, [arXiv.org>cs>arXiv:1206.2669](#), February 2013, ([TR2013-002](#))

Richard, J.C.; Kumar, G.; Kalmar-Nagy, T.; Girimaji, S.S., “**Characterization of Flow-Magnetic Field Interactions in Magneto-Hydrodynamic Turbulence**”, *Journal of Computational and Nonlinear Dynamics*, Vol. 8, Issue 3, doi: 10.1115/1.4023323, January 2013, ([TR2013-013](#))

Jacques, L.; Laska, J.N.; Boufounos, P.T.; Baraniuk, R.G., “**Robust 1-Bit Compressive Sensing via Binary Stable Embeddings of Sparse Vectors**”, *IEEE Transactions on Information Theory*, ISSN 0018-9448, Vol. 59, Issue 4, pp. 2082-2102, January 2013, ([TR2013-017](#))

Fujii, S.; Yoshimoto, K.; Ueda, K.; Takahashi, S.; Nikovski, D., “**Fast Runcurve Optimization based on Markov Decision Process**”, *Symposium of the Society of Instrumentation and Control Engineers of Japan (SICE)*, January 2013 ([TR2013-003](#))

Kim, K.J.; Duong, T.Q.; Poor, H.V., “**Outage Probability of Single-Carrier Cooperative Spectrum Sharing Systems with Decode-and-Forward Relaying and Selection Combining**”, *IEEE Transactions on Wireless Communications*, ISSN: 1536-1276, Vol. 12, Issue 2, pp. 806-817, January 2013, ([TR2013-006](#))

Ruta, A.; Porikli, F., “**Compressive Clustering of High-Dimensional Data**”, *International Conference on Machine Learning and Applications (ICMLA)*, ISBN: 978-1-4673-4651-1, Vol. 1; pp. 380-385, December 2012, ([TR2012-095](#))

Milic, V.; Di Cairano, S.; Kasac, J.; Bemporad, A.; Sitem, Z., “**A Numerical Algorithm for Nonlinear L2-gain Optimal Control with Application to Vehicle Yaw Stability Control**”, *IEEE Annual Conference on Decision and Control (CDC)*, December 2012, ([TR2012-094](#))

Di Cairano, S.; Pascucci, C.A.; Bemporad, A., “**The Rendezvous Dynamics under Linear Quadratic Optimal Control**”, *IEEE Annual Conference on Decision and Control (CDC)*, ISSN: 0743-1546, pp. 6554-6559, December 2012, ([TR2012-076](#))

Wang, Y.; Ueda, K.; Bortoff, S.A., “**On the Optimal Trajectory Generation for Servomotors: A Hamiltonian Approach**”, *IEEE Annual Conference on Decision and Control (CDC)*, ISSN: 7620-7625, pp. 7620-7625, December 2012, ([TR2012-079](#))

Watanabe, S.; Nakamura, A., “**Bayesian Approaches to Acoustic Modeling: A Review**”, *APSIPA Transactions on Signal and Information Processing*, DOI: <http://dx.doi.org/10.1017/ATSIP.2012.6>, Vol. 1 - 2012, December 2012, ([TR2012-087](#))

Graziosi, D.B.; Tian, D.; Vetro, A., “**Depth Map Up-sampling Based on Edge Layers**”, *Asia-Pacific Signal & Information Processing Association Annual Summit and Conference*, ISBN: 978-1-4673-4863-8, pp. 1-4, December 2012, ([TR2012-065](#))

Jin, G.; Cohen, R.; Vetro, A.; Sun, H., “**Joint Perceptually-based Intra Prediction and Quantization for HEVC**”, *Asia-Pacific Signal & Information Processing Association Annual Summit and Conference*, ISBN: 978-1-4673-4863-8, pp. 1-10, December 2012, ([TR2012-071](#))

Lin, B-R; Wang, Y.; Rane, S., “**A Framework for Privacy Preserving Statistical Analysis on Distributed Databases**”, *IEEE International Workshop on Information Forensics and Security (WIFS)*, E-ISBN: 978-1-4673-2286-7, pp. 61-66, December 2012, ([TR2012-064](#))

Grover, P.; Ross, S.; Stremmler, M.; Kumar, P., “**Topological Chaos, Braiding and Bifurcation of Almost-cyclic Sets**”, *AIP Chaos*, Vol. 22, Issue 4, December 2012, ([TR2012-098](#))

Hershey, J.R.; Rennie, S.J.; Le Roux, J., “**Factorial Models for Noise Robust Speech Recognition**”, *Techniques for Noise Robustness in Automatic Speech Recognition*, Chapter 12, November 2012, ([TR2012-002](#))

Zheng, J.; Liu, M.-Y.; Chellappa, R.; Phillips, P.J., “**A Grassmann Manifold-based Domain Adaptation Approach**”, *IEEE International Conference on Pattern Recognition (ICPR)*, November 2012, ([TR2012-092](#))

Sun, M.; Demirtas, S.; Sahinoglu, Z., “**Joint Voltage and Phase Unbalance Detector for Three Phase Power Systems**”, *IEEE Signal Processing Letters*, ISSN: 1070-9908, Vol. 20, Issue 1, pp. 11-14, November 2012, ([TR2012-063](#))

Taguchi, Y.; Jian, Y.-D.; Ramalingam, S.; Feng, C., “**SLAM Using Both Points and Planes for Hand-Held 3D Sensors**”, *International Symposium on Mixed and Augmented Reality (ISMAR)*, November 2012, ([TR2012-091](#))

Gales, M.; Watanabe, S.; Fosler-Lussier, E., “**Structured Discriminative Models For Speech Recognition**”, *IEEE Signal Processing Magazine*, Volume: 29, Issue: 6, Page(s): 70- 81, November 2012, ([TR2012-072](#))

Sun, H.; Dubey, A.; Nikovski, D.; Ohno, T.; Takano, T.; Kojima, Y., “**Decoupled Three-Phase Load Flow Method for Unbalanced Distribution Systems**”, *IEEE International Conference on Power System Technology (POWERCON)*, October 2012, ([TR2012-086](#))

Li, L.; Annavajjala, R.; Koike-Akino, T.; Orlik, P., “**Robust Receiver Algorithms to Mitigate Partial-Band and Partial-Time Interference in LDPC-coded OFDM Systems**”, *IEEE Military Communications Conference (MILCOM)*, October 2012, ([TR2012-084](#))

Yerazunis, W.; Wang, B.; Teo, K.H., “**Power Delivery Optimization for a Mobile Power Transfer System based on Resonator Arrays**”, *IEEE International Symposium on Antennas and Propagation (ISAP)*, October 2012, ([TR2012-085](#))

Erdim, H.; Sullivan, A., “**High Accuracy Computation of Geometric Properties of Cutter Workpiece Intersection using Distance Fields for NC Milling**”, *CIRP Conference on Process Machine Interactions (PMI)*, Vol. 4, 2012, pp. 84-89, October 2012, ([TR2012-093](#))

Ellstein, D.; Wang, B.; Teo, K.H., “**Accurate Models for Spiral Resonators**”, *European Microwave Week (EuMW)*, October 2012, ([TR2012-089](#))

Zhang, J.; Borowsky, A.; Schmidt-Nielsen, B.; Harsham, B.; Weinberg, G.; Romoser, M.R.E.; Fisher, D.L., “**Evaluation of Two Types of In-Vehicle Music Retrieval and Navigation Systems**”, *Annual Meeting of the Human Factors and Ergonomics Society (HFES)*, October 2012, ([TR2012-097](#))

Zhao, Y., “**Decentralized Finite-Time Stabilizing Feedback Network Control**”, *ASME Dynamic Systems and Control Conference*, October 2012, ([TR2012-100](#))

Nikovski, D.; Lidicky, B.; Zhang, W.; Kataoka, K.; Yoshimoto, K., “**Markov Decision Processes for Train Run Curve Optimization**”, *Electrical Systems for Aircraft, Railway and Ship Propulsion (ESARS)*, ISSN: 2165-9400, pp. 1-6, October 2012, ([TR2012-083](#))

Sun, H.; Nikovski, D.; Ohno, T.; Takano, T.; Kojima, Y., “**Hybrid Three-Phase Load Flow Method for Ungrounded Distribution Systems**”, *IEEE PES Innovative Smart Grid Technologies Europe (ISGT Europe)*, October 2012, ([TR2012-082](#))

Hodlmoser, M.; Micusik, B.; Liu, M.-Y.; Pollefeys, M.; Kaampel, M., “**Classification and Pose Estimation of Vehicles in Videos by 3D Modeling within Discrete-Continuous Optimization**”, *IEEE International Conference on 3D Imaging, Modeling, Processing, Visualization and Transmission (3DIMPVT)*, DOI: 10.1109/3DIMPVT.2012.23, October 2012, ([TR2012-081](#))

Taguchi, Y., “**Rainbow Flash Camera: Depth Edge Extraction Using Complementary Colors**”, *European Conference on Computer Vision (ECCV)*, Lecture Notes In Computer Science Vol. 7577, 2012, pp 513-527, October 2012, ([TR2012-078](#))

Taguchi, Y.; Agrawal, A.; Tuzel, O., “**Motion-Aware Structured Light Using Spatio-Temporal Decodable Patterns**”, *European Conference on Computer Vision (ECCV)*, October 2012, ([TR2012-077](#))

Zhu, M.; Ramalingam, S.; Taguchi, Y.; Garaas, T., “**Monocular Visual Odometry and Dense 3D Reconstruction for On-Road Vehicles**”, *European Conference on Computer Vision (ECCV)*, Vol. 7584, 2012, pp 596-606, October 2012, ([TR2012-080](#))

Gopalakrishnan, A.; Raghunathan, A.U.; Nikovski, D.; Biegler, L.T., “**Global Optimization of Optimal Power Flow Using a Branch & Bound Algorithm**”, *Allerton Conference on Communication, Control, and Computing*, October 2012, ([TR2012-088](#))

Wang, Y.; Tian, D.; Vetro, A., “**A Local Depth Image Enhancement Scheme for View Synthesis**”, *IEEE International Conference on Image Processing (ICIP)*, September 2012, ([TR2012-070](#))

Cheung, N.-M.; Tian, D.; Vetro, A.; Sun, H., “**On Modeling the Rendering Error in 3D Video**”, *IEEE International Conference on Image Processing (ICIP)*, September 2012, ([TR2012-069](#))

Rane, S.; Sun, W., “**An Attribute-Based Framework for Privacy Preserving Image Querying**”, *IEEE International Conference on Image Processing (ICIP)*, Session: Recent Advances in Cryptography & Image Processing Paper WP.L1.6, September 2012, ([TR2012-066](#))

Puech, W.; Erkin, Z.; Barni, M.; Rane, S.; Lagendijk, R.L., “**Emerging Cryptographic Challenges in Image and Video Processing**”, *IEEE International Conference on Image Processing (ICIP)*, Session: recent Advances in Cryptography & Image Processing, Paper: WP.L1.1, October 2012, ([TR2012-067](#))

Ramalingam, S.; Taguchi, Y., “**A Theory of Minimal 3D Point to 3D Plane Registration and Its Generalization**”, *International Journal of Computer Vision*, DOI: 10.1007/s11263-012-0576-x, September 2012, ([TR2012-075](#))

Li, M.; Rane, S.; Boufounos, P., “**Quantized Embeddings of Scale-Invariant Image Features for Mobile Augmented Reality**”, *IEEE International Workshop on Multimedia Signal Processing (MMSP)*, DOI: 10.1109/MMSP.2012.6343406, pp. 1-6, September 2012, ([TR2012-073](#))

Yuan, W.; Kojima, K.; Wang, B.; Koike-Akino, T.; Parsons, K.; Nishikawa, S.; Yagyu, E., “**An MMI-based Polarization Splitter Using Patterned Metal and Tilted Joint**”, *European Conference on Optical Communication (ECOC)*, Vol. 20, Issue 26, pp. B371-B376, September 2012, ([TR2012-038](#))

Zhu, P.; Knyazev, A., “**Principal angles between subspaces and their tangents**”, *arXiv*, September 2012, ([TR2012-058](#))

Xu, K.; Orlik, P.; Nagai, Y.; Saito, M., “**Location Based Data Delivery Schedulers for Vehicle Telematics Applications**”, *IEEE Vehicular Technology Conference (VTC)*, September 2012, ([TR2012-074](#))

Liu, L.; Zhang, J.; Yi, Y.; Li, H.; Zhang, J., “**Combating Interference: MU-MIMO, CoMP, and HetNet**”, *Journal of Communications*, Vol. 7, Issue 9, pp. 646-655, September 2012, ([TR2012-027](#))

Guo, Y.; Lee, M.H.; Kim, K.J., “**An Explicit Construction of Fast Cocyclic Jacket Transform on the Finite Field with Any Size**”, *EURASIP Journal on Advances in Signal Processing*, article part of Signal Processing Methods for Diversity and Its Applications, August 2012, ([TR2012-101](#))

Di Cairano, S., “**An Industry Perspective on MPC in Large Volumes Applications: Potential Benefits and Open Challenges**”, *IFAC Nonlinear Model Predictive Control Conference (NMPC)*, August 2012, ([TR2012-061](#))

Guo, J.; Han, C.; Orlik, P.; Zhang, J.; Ishibashi, K., “**Loop-Free Routing in Low-Power and Lossy Networks**”, *International Conference on Sensor Technologies and Applications (SENSORCOMM)*, ISBN: 978-1-61208-207-3, Pages 59-66, August 2012, ([TR2012-060](#))

Boufounos, P.; Cevher, V.; Gilbert, A.C.; Li, Y.; Strauss, M.J., “**What's the Frequency, Kenneth?: Sublinear Fourier Sampling Off the Grid**”, *Approximation, Randomization, and Combinatorial Optimization. Algorithms and Techniques - International Workshops APPROX/RANDOM*, Vol 7408, 2012, pp.61-72, August 2012, ([TR2012-059](#))

Grover, P.; Sato, Y., “**Efficient Estimation and Uncertainty Quantification in Space Mission Dynamics**”, *AIAA/AAS Astrodynamics Specialist Conference*, DOI: 10.2514/6.2012-5062, August 2012, ([TR2012-062](#))

Vetro, A.; Tian, D., “**Analysis of 3D and Multiview Extensions of the Emerging HEVC Standard**”, *SPIE Conference on Applications of Digital Image Processing*, Paper 8499-33, August 2012, ([TR2012-068](#))

Di Cairano, S.; Park, H.; Kolmanovsky, I., “**Model Predictive Control Approach for Guidance of Spacecraft Rendezvous and Proximity Maneuvering**”, *International Journal of Robust and Nonlinear Control*, Vol. 22, Issue 12, pp. 1398-1427, August 2012, ([TR2012-099](#))

Wang, Y.; Rane, S.; Draper, S.C.; Ishwar, P., “**A Theoretical Analysis of Authentication, Privacy, and Reusability Across Secure Biometric Systems**”, *IEEE Transactions on Information Forensics and Security*, ISSN: 1556-6013, Vol. 7, Issue 6, pp. 1825-1840, July 2012, ([TR2012-051](#))

Liu, D.; Boufounos, P.T., “**Pan-Sharpening with Multi-scale Wavelet Dictionary**”, *IEEE International Geoscience and Remote Sensing Symposium (IGARSS)*, Paper TH2.5.2, July 2012, ([TR2012-057](#))

Laughman, C.R.; Zhao, Y.; Nikovski, D., “**Fast Refrigerant Property Calculations Using Interpolation-Based Methods**”, *International Refrigeration and Air conditioning Conference at Purdue*, July 2012, ([TR2012-056](#))

Sun, W.; Rane, S., “**A Distance-sensitive Attribute Based Cryptosystem for Privacy-Preserving Querying**”, *IEEE International Conference on Multimedia and Expo (ICME)*, DOI: 10.1109/ICME.2012.64, pp. 386-391, July 2012, ([TR2012-054](#))

Burns, D.J.; Laughman, C., “**Extremum Seeking Control for Energy Optimization of Vapor Compression Systems**”, *International Refrigeration and Air conditioning Conference at Purdue*, ID: 2192, July 2012, ([TR2012-037](#))



Sorensen, J.H.; Koike-Akino, T.; Orlik, P., “**Rateless Feedback Codes**”, *IEEE International Symposium on Information Theory (ISIT)*, DOI: 10.1109/ISIT.2012.6283582, pp. 1767-1771, July 2012, ([TR2012-052](#))

Sorensen, J.H.; Koike-Akino, T.; Orlik, P.; Ostergaard, J.; Popovski, P., “**Ripple Design of LT Codes for AWGN Channel**”, *IEEE International Symposium on Information Theory (ISIT)*, DOI: 10.1109/ISIT.2012.6283580, pp. 1757-1761, July 2012, ([TR2012-053](#))

Nikovski, D.; Esenther, A.; Ye, X.; Shiba, M.; Takayama, S., “**Bayesian Networks for Matcher Composition in Automatic Schema Matching**”, *International Conference on Enterprise Information Systems (ICEIS)*, Vol. 1, pp. 48-55, June 2012, ([TR2012-050](#))

Di Cairano, S.; Kolmanovsky, I.V., “**Further Developments and Applications of Network Reference Governor for Constrained Systems**”, *American Control Conference (ACC)*, ISSN: 0743-1619, pp. 3907-3912, June 2012, ([TR2012-048](#))

Shilpiekandula, V.; Bortoff, S.A.; Barnwell, J.C.; El Rifai, K., “**Load Positioning in the Presence of Base Vibrations**”, *American Control Conference (ACC)*, ISSN: 0743-1619, pp. 6282-6287, June 2012, ([TR2012-049](#))

Koike-Akino, T.; Duan, C.; Parsons, K.; Kojima, K.; Yoshida, T.; Sugihara, T.; Mizuochi, T., “**High-order Statistical Equalizer for Nonlinearity Compensation in Dispersion-managed Coherent Optical Communications**”, *Optics Express*, DOI: 10.1364/OE.20.015769, Vol. 20, Issue 14, pp. 15769-15780, June 2012, ([TR2012-055](#))

Chi, Y.; Porikli, F., “**Connecting the Dots in Multi-Class Classification: From Nearest Subspace to Collaborative Representation**”, *IEEE Conference on Computer Vision and Pattern Recognition (CVPR)*, pp. 3602-3609, June 2012, ([TR2012-043](#))

Wu, D.; O'Toole, M.; Velten, A.; Agrawal, A.; Raskar, R., “**Decomposing Global Light Transport using Time of Flight Imaging**”, *IEEE Conference on Computer Vision and Pattern Recognition (CVPR)*, DOI: 10.1109/CVPR.2012.6247697, pp. 366-373, June 2012, ([TR2012-042](#))

Agrawal, A.; Ramalingam, S.; Taguchi, Y.; Chari, V., “**A Theory of Multi-Layer Flat Refractive Geometry**”, *IEEE Conference on Computer Vision and Pattern Recognition (CVPR)*, pp. 3346-3353, June 2012, ([TR2012-047](#))

Goyette, N.; Jodoin, P.-M.; Porikli, F.; Konrad, J.; Ishwar, P., “**Changedetection.net: A New Change Detection Benchmark Dataset**”, *IEEE Conference on Computer Vision and Pattern Recognition (CVPR)*, DOI: 10.1109/CVPRW.2012.6238919, pp. 1-8, June 2012, ([TR2012-044](#))

Wang, Y.; Ishwar, P.; Rane, S., “**Information-Theoretically Secure Three-party Computation with One Active Adversary**”, *arXiv*, June 2012, ([TR2012-045](#))

Shi, W.; Annavaajjala, R.; Orlik, P.V.; Molisch, A.F.; Ochiari, M.; Taira, A., “**Non-coherent ToA Estimation for UWB Multipath Channels using Max-eigenvalue Detection**”, *IEEE International Conference on Communications (ICC)*, June 2012, (TR2012-046)

Layegh, S.E.; Erdim, H.; Lazoglu, I., “**Offline Force Control and Feedrate Scheduling for Complex Free Form Surfaces in 5-Axis Milling**”, *CIRP Conference on High Performance Cutting*, Vol. 1, 2012, pp. 96-101, June 2012, (TR2012-041)

Sullivan, A.; Erdim, H.; Perry, R.N.; Frisken, S.F., “**High Accuracy NC Milling Simulation Using Composite Adaptively Sampled Distance Fields**”, *Computer-Aided Design*, Vol. 44, Issue 6, pp. 522-536, June 2012, (TR2012-025)

Wittenburg, K.; Malizia, A.; Lupo, L.; Pekhteryev, G., “**Visualizing Set-valued Attributes in Parallel with Equal-height Histograms**”, *International Working Conference on Advanced Visual Interfaces (AVI)*, ISBN: 978-1-4503-1287-5, pp. 632-635, May 2012, (TR2012-040)

Sun, H.; Wang, Z.; Nikovski, D., “**Two-Level State Estimation Method for Power Systems with SCADA and PMU Measurements**”, *IEEE Innovative Smart Grid Technologies - Asia (ISGT Asia)*, DOI : 10.1109/ISGT-Asia.2012.6303127pp. 1-5, May 2012, (TR2012-028)

Joshi, A.J.; Porikli, F.; Papanikolopoulos, N., “**Coverage Optimized Active Learning for k - NN Classifiers**”, *IEEE International Conference on Robotics and Automation (ICRA)*, DOI: 10.1109/ICRA.2012.6225054, pp. 5353-5358, May 2012, (TR2012-036)

Chari, V.; Agrawal, A.; Taguchi, Y.; Ramalingam, S., “**Convex Bricks: A New Primitive for Visual Hull Modeling and Reconstruction**”, *IEEE International Conference on Robotics and Automation (ICRA)*, pp: 770-777, May 2012, (TR2012-033)

Choi, C.; Taguchi, Y.; Tuzel, O.; Liu, M.-Y.; Ramalingam, S., “**Voting-based Pose Estimation for Robotic Assembly Using a 3D Sensor**”, *IEEE International Conference on Robotics and Automation (ICRA)*, DOI: 10.1109/ICRA.2012.6225371, pp. 1724-1731, May 2012, (TR2012-032)

Romero, R.; Diez, D.; Wittenburg, K.; Diaz, P., “**Envisioning Grid Vulnerabilities: Multi-dimensional Visualization for Electrical Grid Planning**”, *International Working Conference on Advanced Visual Interfaces (AVI)*, ISBN: 978-1-4503-1287-5, pp. 701-704, May 2012, (TR2012-039)

Liu, M.-Y.; Tuzel, O.; Veeraraghavan, A.; Taguchi, Y.; Marks, T.K.; Chellappa, R., “**Fast Object Localization and Pose Estimation in Heavy Clutter for Robotic Bin Picking**”, *The International Journal of Robotics Research*, May 2012, (TR2012-007)

Xu, X.; Cohen, R.; Vetro, A.; Sun, H., “**Predictive Coding of Intra Prediction Modes for High Efficiency Video Coding**”, *Picture Coding Symposium (PCS)*, DOI: 10.1109/PCS.2012.6213253, pp. 457-460, May 2012, (TR2012-035)

Gou, T.; Koike-Akino, T.; Orlik, P., **“Improved and Opportunistic Interference Alignment Schemes for Multi-Cell Interference Channels”**, *IEEE Vehicular Technology Conference (VTC)*, DOI: 10.1109/VETECS.2012.6240353, pp. 1-5, May 2012, ([TR2012-034](#))

Yuan, W.; Kojima, K.; Wang, B.; Koike-Akino, T.; Parsons, K.; Nishikawa, S.; Yagyu, E., **“Mode-evolution-based Polarization Rotator-splitter Design via Simple Fabrication Process”**, *Optics Express*, Vol. 20, Issue 9, pp. 10163-10169, April 2012, ([TR2012-006](#))

Shroff, N.; Veeraraghavan, A.; Taguchi, Y.; Tuzel, O.; Agrawal, A.; Chellappa, R., **“Variable Focus Video: Reconstructing Depth and Video for Dynamic Scenes”**, *Computational Photography (ICCP), 2012 IEEE International Conference on*, 28-29 April 2012, Pages 1-9, April 2012, ([TR2012-030](#))

Porikli, F.; Sundaresan, R.; Suwa, K., **“SAR Despeckle Filtering by Sparse Coding on Affinity Nets (SCAN)”**, *European Conference on Synthetic Aperture Radar (EUSAR)*, ISBN: 978-3-8007-3404-7, pp. 796-799, April 2012, ([TR2012-029](#))



## Research

The body and soul of any research lab is the portfolio of research it pursues. Therefore it is appropriate that the main body of this annual report consists of descriptions of research projects being done at MERL. For ease of reference, the reports are grouped into six topic areas.

**Digital Communications** - Advanced wireless and optical communications, highly reliable machine-to-machine networks, advanced coding/decoding, adaptive signal processing, and smart grid standards and technologies.

**Multimedia** – Efficient representation, transmission, security, processing and interaction of multimedia including video compression, display processing, information coding for security, compressive sensing, and speech processing.

**Data Analytics** – Predictive analytics (statistical machine learning, data analysis), Decision analytics (optimization, scheduling and control), and software infrastructure (distributed software systems, data stream processing).

**Imaging** - Detection, classification, and recognition based on machine learning and physical modeling; 3D reconstruction, location, and inference; computational imaging for optimized information capture; Dictionary Learning for signal processing; tracking and multi-modal sensor integration.

**Mechatronics** - Advanced control algorithms, nonlinear dynamical systems, system modeling & dynamic analysis, mechatronics design, innovative system concepts, and 3D adaptively-sampled distance fields applications.

**Algorithms** - Solution methods for optimization problems involving very large numbers of variables in the areas of information theory & coding; stochastic network utility maximization; sensing, perception, inference & learning.



## Digital Communications

The Digital Communications Group conducts fundamental and applied research in the areas of wireless and optical communications, advanced signal processing, optical and semiconductor devices, and electro-magnetics. Our research has application to product areas such as terrestrial and trans-oceanic optical networks, train and automotive connectivity and electronics, power equipment and systems for smart grid, RF power amplifiers and front-end modules, and wireless charging.

Wireless research focuses on the development of novel physical and network layer algorithms, combined with advanced channel modeling, to enable high reliability wireless networks for machine-to-machine networking, high mobility systems and vehicular networks. Our signal processing work involves detection, localization and applied optimization algorithms for applications such as Smart Grid.

Optical work focuses on signal processing algorithms and error control coding for coherent long haul and sub-sea fiber-optic communications, and the development of novel photonic integrated circuits to support optical communications applications.

Power & RF work emphasizes highly-efficient wideband power amplifier technology and semiconductor devices, as well as electro-magnetic analysis and manipulation, for applications such as wireless power transfer to static and mobile devices.

### Recent Research

Generalized DC-link Voltage Balancing Control Method for Multilevel Inverters .....	36
Joint Voltage and Phase Unbalance Detector for Three Phase Power Systems .....	36
Robust Receiver Algorithms to Mitigate Partial-Band and Partial-Time Interference ... ..	37
Accurate Models for Spiral Resonators .....	37
Location Based Data Delivery Schedulers for Vehicle Telematics Applications .....	38
Loop-Free Routing in Low-Power and Lossy Networks.....	38
Rateless Feedback Codes.....	39
High-order Statistical Equalizer for Nonlinearity Compensation ... ..	39
An MMI-based Polarization Splitter Using Patterned Metal and Tilted Joint.....	40
Non-coherent ToA Estimation for UWB Multipath Channels using Max-eigenvalue Detection	40
Mode-Evolution-Based Polarization Rotator-Splitter Design via Simple Fabrication Process....	41
Ripple Design of LT Codes for AWGN Channel.....	41

# Generalized DC-link Voltage Balancing Control Method for Multilevel Inverters

Citation: Deng, Y.; Teo, K.H.; Harley, R.G., “Generalized DC-link Voltage Balancing Control Method for Multilevel Inverters”, *IEEE Applied Power Electronics Conference and Exposition (APEC)*, ISSN: 1048-2334, pp. 1219-1225, March 2013

Contacts: Koon Hoo Teo

This paper presents a general dc-link voltage balancing control method for multilevel inverters based on a generalized space vector pulse width modulation (SVPWM) scheme, with no requirements for additional auxiliary- power circuits. The SVPWM scheme generates all the available switching states and switching sequences based on two simple mappings, and calculates the duty cycles simply as for a two level SVPWM, thus independent of the level of the inverter. The optimal switching sequence and optimal duty cycles for dc-link voltage balancing control are provided in the paper. The dc-link voltage balancing control in the paper is effective even when the capacitances of the dc-link capacitors of the multilevel inverter are not strictly equal or the voltage of the dc source of the multilevel inverter is fluctuating. Simulation results for a five-level inverter are given.

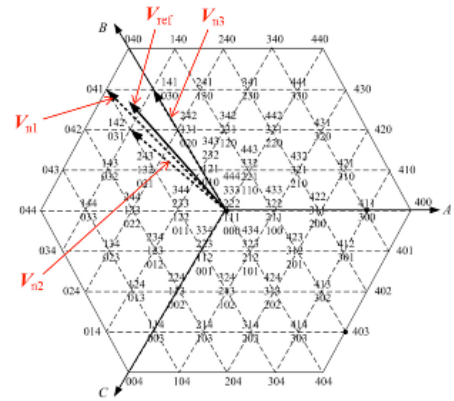

Fig. 2. Space vector diagram of a five-level inverter

## Joint Voltage and Phase Unbalance Detector for Three Phase Power Systems

Citation: Sun, M.; Demirtas, S.; Sahinoglu, Z., “Joint Voltage and Phase Unbalance Detector for Three Phase Power Systems”, *IEEE Signal Processing Letters*, ISSN: 1070-9908, Vol. 20, Issue 1, pp. 11-14, November 2012

Contacts: Zafer Sahinoglu

This letter develops a fast detection algorithm for voltage and phase unbalance in three phase power systems. It is suitable for real time applications since the required observation length is one cycle. It is shown to successfully detect small unbalance conditions at low SNRs. Its detection performance is shown to outperform traditional detectors that rely on changes in only a subset of positive, negative and zero sequence voltages. Unbalance detection is formulated as a hypothesis test under a framework of detection theory and solved by applying a generalized likelihood ratio test (GLRT). We first obtain an approximate maximum likelihood estimate (MLE) of the system frequency and then use it to substitute the true unknown frequency in the GLRT. A closed form expression is provided to detect unbalance conditions.

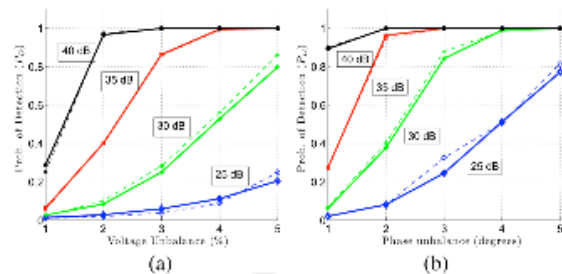

Fig. 2. Unbalance versus probability of detection at SNR levels of 25 dB, 30 dB, 35 dB and 40 dB. Note: theoretical (dashed), simulation (solid), and  $\sigma^2$  is known. (a) Voltage unbalance. (b) Phase unbalance.



## Robust Receiver Algorithms to Mitigate Partial-Band and Partial-Time Interference in LDPC-coded OFDM Systems

Citation: Li, L.; Annavajjala, R.; Koike-Akino, T.; Orlik, P.V., “Robust Receiver Algorithms to Mitigate Partial-Band and Partial-Time Interference in LDPC-coded OFDM Systems”, *IEEE Military Communications Conference (MILCOM)*, October 2012

Contacts: Toshiaki Koike-Akino, Philip V. Orlik

Orthogonal frequency division multiplexing (OFDM) systems are vulnerable to narrow-band jamming signals. We propose robust, yet simple, receiver algorithms consisting of both channel estimation and information decoding. The receiver conducts threshold tests to detect interference followed by pilot erasure and channel estimation. Then, channel estimation error and unknown interference statistics are dealt with by the robust log-likelihood ratio (LLR) calculations for soft iterative decoding. The proposed receiver algorithm does not require any statistical knowledge of interference and its complexity is linear against the length of code-words.

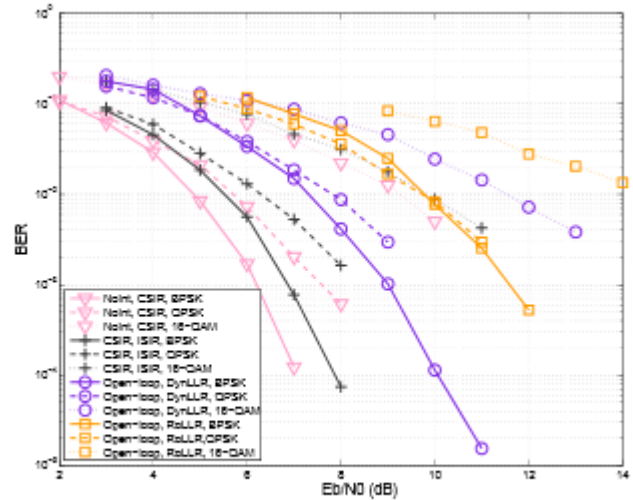

Fig. 3. BER comparison with genie systems for different constellations at  $K = 50$  and  $ISR = 20\text{dB}$ .

## Accurate Models for Spiral Resonators

Citation: Ellstein, D.; Wang, B.; Teo, K.H., “Accurate Models for Spiral Resonators”, *European Microwave Week (EuMW)*, October 2012

Contacts: Bingnan Wang, Koon Hoo Teo

Analytically-based circuit models for two types of spiral resonators, a single layer and a double layer spiral, are given. The models are suitable for various spiral and wire cross-sectional shapes. The double layer spiral is composed of two identical spirals of opposite winding in which the inner or outer leads may or may not be connected, such as through a via. For both types, the model can account for the effect of a dielectric slab. The advantage of these models to previous circuit models is shown through their comparison to experimental measurements and numerical simulations.

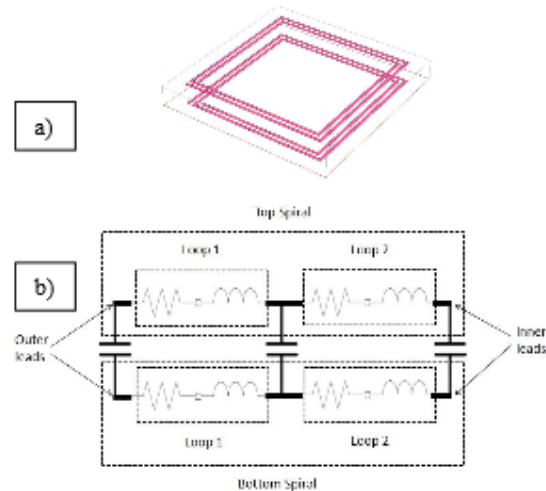

Fig. 2. A double layer spiral: a) physical structure and b) circuit model.

## Location Based Data Delivery Schedulers for Vehicle Telematics Applications

Citation: Xu, K.; Orlik, P.V.; Nagai, Y.; Saito, M., "Location Based Data Delivery Schedulers for Vehicle Telematics Applications", *IEEE Vehicular Technology Conference (VTC)*, September 2012

Contacts: Philip V. Orlik

This paper proposes four schedulers using location information and side information in telematics applications for vehicular networks. The scheduler algorithms consider peak traffic and link reliability, achieving savings of channel resources and reducing the number of retransmissions. A key feature of the proposed schedulers is they use side information in the form of a coverage map, which provides a map of link quality for the area covered by the radio access networks. The total offered load and average excess delay are considered as two metrics for measuring the proposed schedulers, which are evaluated by simulation results.

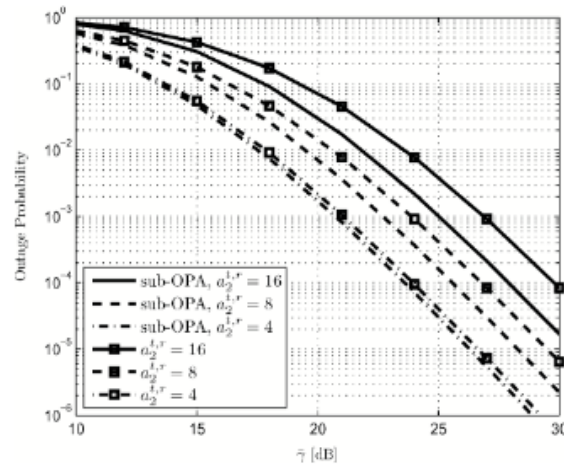

Fig. 6. Outage probabilities for various values of channel  $\alpha_2^{l,r}$  with and without OPA.

## Loop-Free Routing in Low-Power and Lossy Networks

Citation: Guo, J.; Han, C.; Orlik, P.V.; Zhang, J.; Ishibashi, K., "Loop-Free Routing in Low-Power and Lossy Networks", *International Conference on Sensor Technologies and Applications (SENSORCOMM)*, ISBN: 978-1-61208-207-3, Pages 59-66, August 2012

Contacts: Jianlin Guo, Philip V. Orlik, Jinyun Zhang

IPv6 based Low-Power and Lossy Networks (LLNs) are emerging. Internet Engineering Task Force (IETF) has developed an IPv6 Routing Protocol for LLNs (RPL), which is widely considered as a feasible routing protocol for LLNs. However, routing loops and lack of a loop-free local route repair mechanism are two major open issues to be addressed in RPL. Based on the framework of RPL, this paper proposes a Loop-Free Routing Protocol for LLNs (LRPL). We provide an innovative rank computation method and a loop-free local route repair mechanism to eliminate routing loops in RPL. Simulation results show that the proposed LRPL performs much better than conventional routing protocols in terms of packet delivery rate, end-to-end packet delay, and routing overhead.

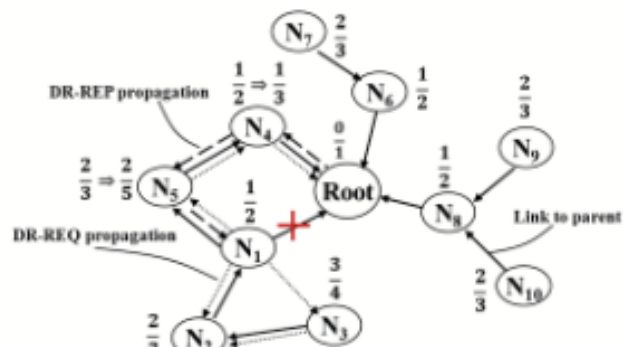

Figure 8. Example of the DODAG Local Repair

## Rateless Feedback Codes

Citation: Sorensen, J.H.; Koike-Akino, T.; Orlik, P.V., "Rateless Feedback Codes", *IEEE International Symposium on Information Theory (ISIT)*, DOI: 10.1109/ISIT.2012.6283582, pp. 1767-1771, July 2012  
 Contacts: Toshiaki Koike-Akino, Philip V. Orlik

This paper proposes a concept called rateless feedback coding. We redesign the existing LT and Raptor codes, by introducing new degree distributions for the case when a few feedback opportunities are available. We show that incorporating feedback to LT codes can significantly decrease both the coding overhead and the encoding/decoding complexity. Moreover, we show that, at the price of a slight increase in the coding overhead, linear complexity is achieved with Raptor feedback coding.

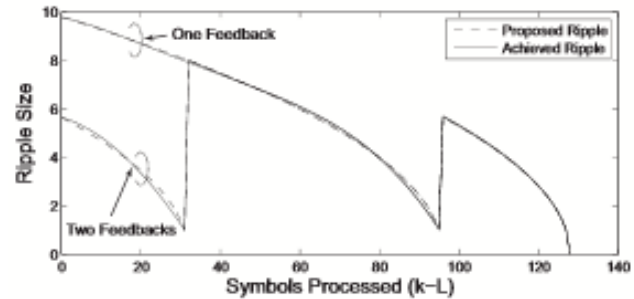

Fig. 3. The achieved ripple evolution compared to the proposed.

## High-order Statistical Equalizer for Nonlinearity Compensation in Dispersion-managed Coherent Optical Communications

Citation: Koike-Akino, T.; Duan, C.; Parsons, K.J.; Kojima, K.; Yoshida, T.; Sugihara, T.; Mizuochi, T., "High-order Statistical Equalizer for Nonlinearity Compensation in Dispersion-managed Coherent Optical Communications", *Optics Express*, DOI: 10.1364/OE.20.015769, Vol. 20, Issue 14, pp. 15769-15780, June 2012  
 Contacts: Toshiaki Koike-Akino, Chunjie Duan, Keisuke Kojima, Kieran J. Parsons

Fiber nonlinearity has become a major limiting factor to realize ultra-high-speed optical communications. We propose a fractionally-spaced equalizer which exploits trained high-order statistics to deal with data-pattern dependent nonlinear impairments in fiber-optic communications. Computer simulation reveals that the proposed 3-tap equalizer improves Q-factor by more than 2 dB for long-haul transmissions of 5,230 km distance and 40 Gbps data rate. We also demonstrate that the joint use of a digital backpropagation (DBP) and the proposed equalizer offers an additional 1-2 dB performance improvement due to the channel shortening gain.

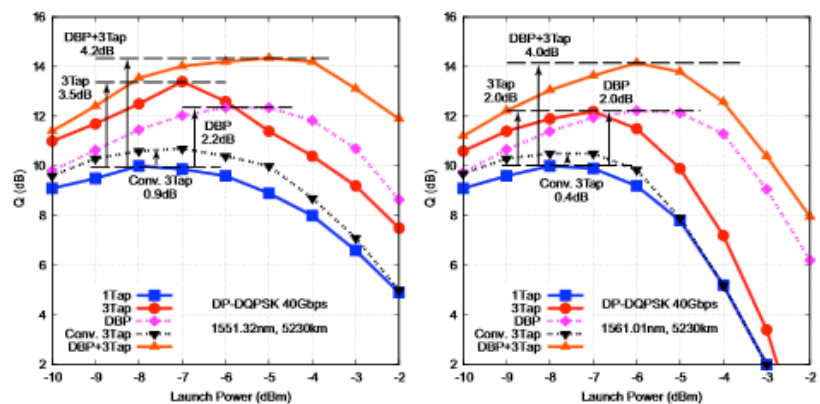

Fig. 4. Simulation results of Q-factor performance as a function of launching power for 40 Gbps DP-DQPSK (5,230 km). (a) Low local dispersion channel (1551.32 nm). (b) High local dispersion channel (1561.01 nm).

## An MMI-based Polarization Splitter Using Patterned Metal and Tilted Joint

Citation: Yuan, W.; Kojima, K.; Wang, B.; Koike-Akino, T.; Parsons, K.J.; Nishikawa, S.; Yagyu, E., "An MMI-based Polarization Splitter Using Patterned Metal and Tilted Joint", *European Conference on Optical Communication (ECOC)*, Vol. 20, Issue 26, pp. B371-B376, September 2012

Contacts: Keisuke Kojima, Toshiaki Koike-Akino, Kiernan J. Parsons, Bingnan Wang

A novel polarization splitter on an InP substrate utilizing an MMI coupler with a patterned gold layer and a tilted joint is proposed. Simulations show that the device has a polarization extinction ratio over 23 dB and an insertion loss below 0.7 dB over the entire C-band for both TE and TM polarizations.

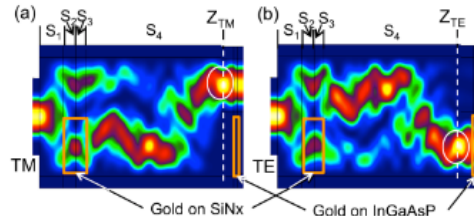

Fig. 3: The electric field intensity in the MMI-based polarization splitter showing the wave propagation for (a) TM<sub>0</sub> mode and (b) TE<sub>0</sub> mode inputs.

## Non-coherent ToA Estimation for UWB Multipath Channels using Max-eigenvalue Detection

Citation: Shi, W.; Annavajjala, R.; Orlik, P.V.; Molisch, A.F.; Ochiari, M.; Taira, A., "Non-coherent ToA Estimation for UWB Multipath Channels using Max-eigenvalue Detection", *IEEE International Conference on Communications (ICC)*, June 2012

Contacts: Philip V. Orlik

Due to the fine delay resolution in ultra-wideband (UWB) wireless propagation channels, a large number of multipath components (MPC) can be resolved; and the first arriving MPC might not be the strongest one. This makes time-of-arrival (ToA) estimation, which essentially depends on determining the arrival time of the first MPC, highly challenging. In this paper, we consider non-coherent ToA estimation given a number of measurement trials, at moderate sampling rate and in the absence of knowledge of pulse shape. The proposed ToA estimation is based on detecting the presence of a signal in a moving time delay window, by using the largest eigenvalue of the sample covariance matrix of the signal in the window as the test statistic. We show that energy detection can be viewed as a special case of the eigenvalue detection.

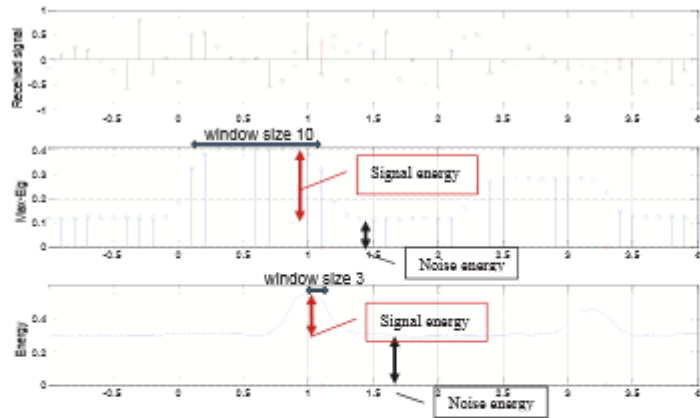

Fig. 2. a) A realization of the received signal under 802.15.3a CM2, where there exist two channel taps at 1.1ns and 3.3ns, the red stems represent the signal after the multipath channel and the black ones noise. b) The max-eigenvalue samples, where the x-axis indicates the start time of the moving window. For a threshold  $1.4\sigma_n^2$ , the earliest larger-than-threshold window is located at [0.1,1.1], and then the ToA is estimated as the end time 1.1ns. c) The ED output. It is seen that MED has more contrast energy separation between the signal-plus-noise and the noise-only hypotheses.

## Mode-Evolution-Based Polarization Rotator-Splitter Design via Simple Fabrication Process

Citation: Yuan, W.; Kojima, K.; Wang, B.; Koike-Akino, T.; Parsons, K.J.; Nishikawa, S.; Yagy, E., "Mode-evolution-based Polarization Rotator-splitter Design via Simple Fabrication Process", *Optics Express*, Vol. 20, Issue 9, pp. 10163-10169, April 2012

Contacts: Keisuke Kojima, Kieran J. Parsons, Bingnan Wang

A mode-evolution-based polarization rotator-splitter built on InP substrate is proposed by combining a mode converter and an adiabatic asymmetric Y-coupler. The mode converter, consisting of a bi-level taper and a width taper, effectively converts the fundamental TM mode into the second order TE mode without changing the polarization of the fundamental TE mode. The following adiabatic asymmetric Y-coupler splits the fundamental and the second order TE

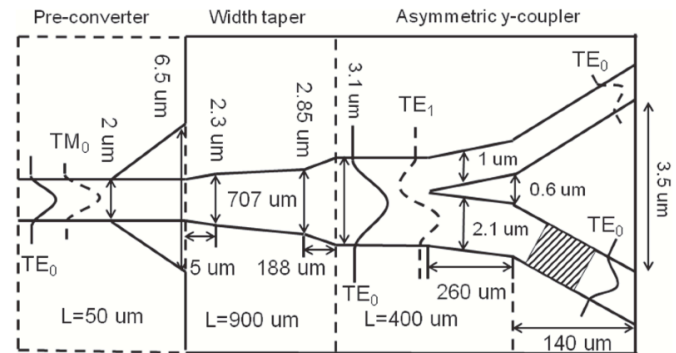

Fig. 5. The geometries of the mode-evolution-based polarization rotator-splitter after optimization.

modes and also converts the second order TE mode into the fundamental TE mode. A shallow etched structure is proposed for the width taper to enhance the polarization conversion efficiency. The device has a total length of 1350  $\mu\text{m}$ , a polarization extinction ratio over 25 dB and an insertion loss below 0.5 dB both for TE and TM modes, over the wavelength range from 1528 to 1612 nm covering all C+L band.

## Ripple Design of LT Codes for AWGN Channel

Citation: Sorensen, J.H.; Koike-Akino, T.; Orlik, P.V.; Ostergaard, J.; Popovski, P., "Ripple Design of LT Codes for AWGN Channel", *IEEE International Symposium on Information Theory (ISIT)*, DOI: 10.1109/ISIT.2012.6283580, pp. 1757-1761, July 2012

Contacts: Toshiaki Koike-Akino, Philip V. Orlik

In this paper, we present an analytical framework for designing LT codes in additive white Gaussian noise (AWGN) channels. We show that some of analytical results from binary erasure channels (BEC) also hold in AWGN channels with slight modifications. This enables us to apply a ripple-based design approach, which until now has only been used in the BEC. LT codes designed this way show promising performance which is near the Shannon limit even with short code-words.

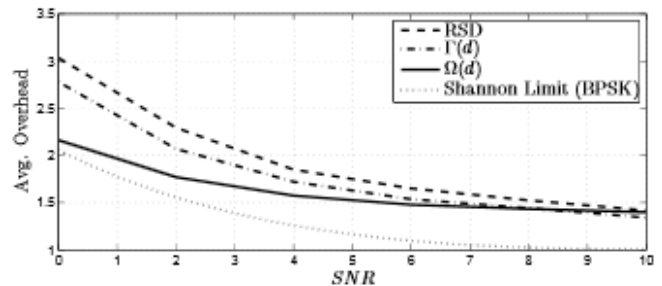

Fig. 5. Average overhead versus SNR for the simulated degree distributions.



# Multimedia

Multimedia research at MERL is centered on the acquisition, representation, processing and security of multimedia, as well as enhanced interaction with multimedia. Core technical strengths are in various aspects of signal processing ranging from video and speech processing to information forensics and security as well as theory and sensing methods. Our research results are applied to a wide range of products including automotive electronics and audio-visual equipment; surveillance and access control systems; space/airborne systems for remote sensing; and information technology systems. We are also actively engaged in the international standardization of next-generation video compression schemes as well as biometric security and related metrics.

Digital video research focuses on 3D video coding, perceptual video coding, distributed source coding, and visual inference. We are also engaged in the development of next-generation video compression standards.

Speech and audio research emphasizes speech and multimodal interfaces including voice search, statistical dialog systems and speech enhancement. We are also exploring acoustic modeling, robust acoustic acquisition, and structured learning for speech and audio processing.

Information security work seeks to create technology for privacy-preserving signal processing including secure computation of encrypted signals, as well as computation of statistics from anonymized data.

Research on compressive sensing technology and applications includes signal acquisition and design, signal modeling and reconstruction algorithms, and array signal processing techniques.

## Recent Research

Greedy Sparsity-Constrained Optimization .....	44
Efficient Coding of Signal Distances Using Universal Quantized Embeddings .....	44
Quantized Embeddings of Scale-Invariant Image Features for Mobile Augmented Reality .....	45
Privacy-Preserving Nearest Neighbor Methods: Comparing Signals without Revealing Them.	45
An Attribute-Based Framework for Privacy Preserving Image Querying.....	46
Joint Perceptually-based Intra Prediction and Quantization for HEVC .....	46
Theoretical Analysis of Authentication, Privacy, and Reusability Across Secure Biometric ...	47
Analysis of 3D and Multiview Extensions of the Emerging HEVC Standard .....	47
Pan-Sharpening with Multi-scale Wavelet Dictionary .....	48
Predictive Coding of Intra Prediction Modes for High Efficiency Video Coding .....	48
Consistent Wiener Filtering for Audio Source Separation .....	49
Structured Discriminative Models for Speech Recognition .....	49
Factorial Models for Noise Robust Speech Recognition .....	50
Indirect Model-Based Speech Enhancement .....	50

## Greedy Sparsity-Constrained Optimization

Citation: Bahmani, S.; Raj, B.; Boufounos, P.T., “Greedy Sparsity-Constrained Optimization”, *Journal of Machine Learning Research (JMLR)*, Vol. 14, pp. 807-841, March 2013

Contacts: Petros T. Boufounos

In this paper we propose a greedy algorithm, Gradient Support Pursuit (GraSP), to approximate sparse minima of cost functions of arbitrary form. Should a cost function have a Stable Restricted Hessian (SRH) or a Stable Restricted Linearization (SRL), both of which are introduced in this paper, our algorithm is guaranteed to produce a sparse vector within a bounded distance from the true sparse optimum. Our approach generalizes known results for quadratic cost functions that arise in sparse linear regression and Compressive Sensing. We also evaluate the performance of GraSP through numerical simulations on synthetic and real data, where the algorithm is employed for sparse logistic regression with and without  $\mathbf{2}$ -regularization.

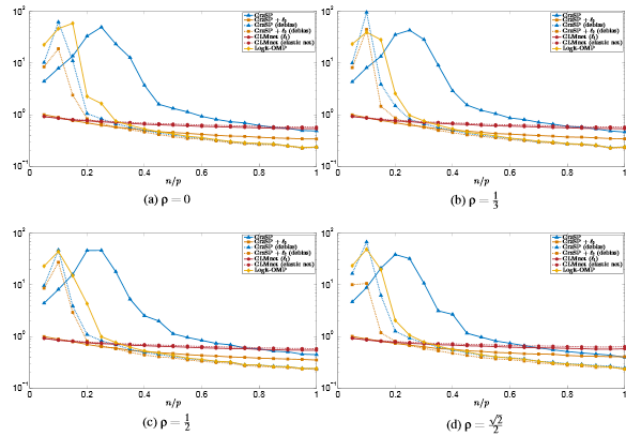

Figure 2: Comparison of the average relative error (i.e.,  $\frac{\|\hat{x} - x^*\|_2}{\|x^*\|_2}$ ) in logarithmic scale at solutions obtained via GraSP, GraSP with  $\ell_2$ -penalty, LASSO, the elastic-net regularization, and Logit-OMP. The results of both GraSP methods with “debiasing” are also included.

## Efficient Coding of Signal Distances Using Universal Quantized Embeddings

Citation: Boufounos, P.T.; Rane, S.D., “Efficient Coding of Signal Distances Using Universal Quantized Embeddings”, *Data Compression Conference (DCC)*, Session 7, March 2012

Contacts: Petros T. Boufounos, Shantanu D. Rane

Traditional rate-distortion theory is focused on how to best encode a signal using as few bits as possible and incurring as low a distortion as possible. However, very often, the goal of transmission is to extract specific information from the signal at the receiving end, and the distortion should be measured on that extracted information. In this paper we examine the problem of encoding signals such that sufficient information is preserved about their pairwise distances. For that goal, we consider randomized embeddings as an encoding mechanism and provide a framework to analyze their performance. We also propose the recently developed universal quantized embeddings as a solution to that problem and experimentally demonstrate that, in image retrieval experiments, universal embedding can achieve up to 25% rate reduction over the state of the art.

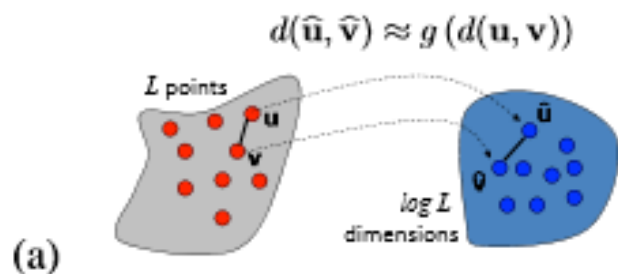



# Quantized Embeddings of Scale-Invariant Image Features for Mobile Augmented Reality

Citation: Li, M.; Rane, S.D.; Boufounos, P.T., "Quantized Embeddings of Scale-Invariant Image Features for Mobile Augmented Reality", *IEEE International Workshop on Multimedia Signal Processing (MMSP)*, DOI: 10.1109/MMSP.2012.6343406, pp. 1-6, September 2012

Contacts: Shantanu D. Rane, Petros T. Boufounos

Randomized embeddings of scale-invariant image features are proposed for retrieval of object-specific meta-data in an augmented reality application. The method extracts scale invariant features from a query image, computes a small number of quantized random projections of these features, and sends them to a database server. The server performs a nearest neighbor search in the space of the random projections and returns meta-data corresponding to the query image. Prior work has shown that binary embeddings of image features enable efficient image retrieval. This paper generalizes the prior art by characterizing the tradeoff between the number of random projections and the number of bits used to represent each projection. The theoretical results suggest a bit allocation scheme under a total bit rate constraint: It is often advisable to spend bits on a small number of finely quantized random measurements rather than on a large number of coarsely quantized random measurements. This theoretical result is corroborated via experimental study of the above tradeoff using the ZuBuD database.

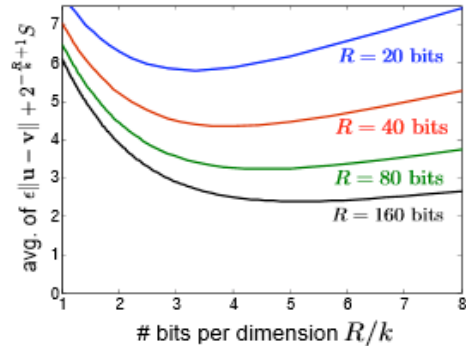

Fig. 4. For the database used, the derived theoretical result (2) indicates that, over a large range of the bit budget  $R$ , there is an optimal bit allocation that achieves the lowest embedding error. This is consistent with the experimental results obtained without recourse to the theory in Fig. 3.

## Privacy-Preserving Nearest Neighbor Methods: Comparing Signals without Revealing Them

Citation: Rane, S.D.; Boufounos, P.T.; "Privacy-Preserving Nearest Neighbor Methods: Comparing Signals without Revealing Them", *IEEE Signal Processing Magazine*, ISSN: 1053-5888, Vol. 30, Issue 2, pp. 18-28, March 2013

Contacts: Shantanu D. Rane, Petros T. Boufounos

Comparing two signals is one of the most essential and prevalent tasks in signal processing. A large number of applications fundamentally rely on determining the answers to the following two questions: (1) How should two signals be compared? (2) Given a set of signals and a query signal, which signals are the nearest neighbors of the query signal; for example, which signals in the database are most similar to the query signal?

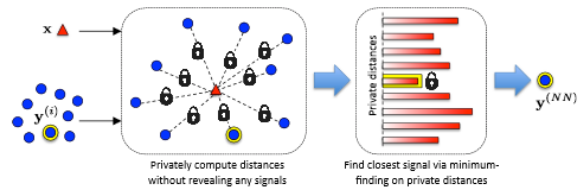

Fig. 1. A PPNN protocol can be broken down into two privacy-preserving protocols.

## An Attribute-Based Framework for Privacy Preserving Image Querying

Citation: Rane, S.D.; Sun, W., "An Attribute-Based Framework for Privacy Preserving Image Querying", IEEE International Conference on Image Processing (ICIP), Session: Recent Advance in Cryptography & Image Processing Paper WP.L1.6, September 2012

Contacts: Shantanu D. Rane

We are specifically concerned with scenarios in which multimedia data is stored once on the server and the same data is queried by multiple parties. We propose a framework for privacy preserving querying, in which encryption is performed only once, and the ciphertexts are stored on a database server. Rather than using public-key homomorphic cryptosystems, the parties querying the database first derive an "attribute" from their query signal. They can decrypt the server's ciphertext only if their attribute satisfies a specified mathematical condition. This query-specific decryption capability makes attribute based cryptography a vital addition to the secure signal processor's toolkit. We give an example of a construction for privacy preserving querying, in which a client can privately retrieve an image from the server if attribute vectors extracted from the server's and client's images are close enough in Euclidean distance.

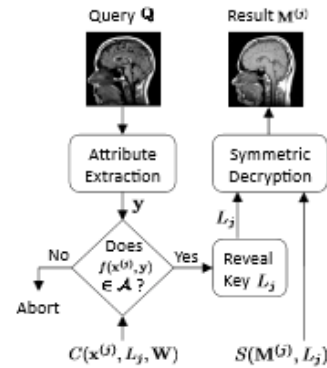

Fig. 3. Alice can decrypt the key  $L_j$  only if her attribute  $y$  satisfies a mathematical condition along with the attribute of the  $j^{\text{th}}$  image. This key enables her to retrieve the  $j^{\text{th}}$  image.

## Joint Perceptually-based Intra Prediction and Quantization for HEVC

Citation: Jin, G.; Cohen, R.A.; Vetro, A.; Sun, H., "Joint Perceptually-based Intra Prediction and Quantization for HEVC", Asia-Pacific Signal & Information Processing Association Annual Summit and Conference, ISBN: 978-1-4673-4863-8, pp. 1-10, December 2012

Contacts: Robert A. Cohen, Huifang Sun, Anthony Vetro

This paper proposes a new coding scheme which jointly applies perceptual quality metrics to prediction, quantization and rate-distortion optimization (RDO) within the High Efficiency Video Coding (HEVC) framework. A new prediction approach which uses template matching is introduced. The template matching uses a structural similarity metric (SSIM) and a Just-Noticeable Distortion (JND) model. The matched candidates are linearly filtered to generate a prediction. We also modify the JND model and use Supra-threshold Distortion (StD) as the distortion measurement in RDO. Experimental results showing improvements for coding textured areas are presented as well.

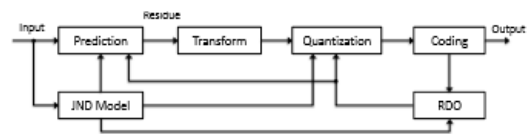

Fig. 2. Proposed Encoder.

# A Theoretical Analysis of Authentication, Privacy, and Reusability Across Secure Biometric Systems

Citation: Wang, Y.; Rane, S.D.; Draper, S.C.; Ishwar, P., “A Theoretical Analysis of Authentication, Privacy and Reusability Across Secure Biometric Systems”, *IEEE Transactions on Information Forensics and Security*, ISSN: 1556-6013, Vol. 7, Issue 6, pp. 1825-1840, July 2012

Contacts: Ye Wang, Shantanu D. Rane

We present a theoretical framework for the analysis of privacy and security tradeoffs in secure biometric authentication systems. We use this framework to conduct a comparative information-theoretic analysis of two biometric systems that are based on linear error correction codes, namely fuzzy commitment and secure sketches. We derive upper bounds for the probability of false rejection (PFR) and false acceptance (PFA) for these systems. We use mutual information to quantify the information leaked about a user's biometric identity, in the scenario where one or multiple biometric enrollments of the user are fully or partially compromised. We also quantify the probability of successful attack (PSA) based on the compromised information. Our analysis reveals that fuzzy commitment and secure sketch systems have identical PFR; PFA; PSA and information leakage, but secure sketch systems have lower storage requirements.

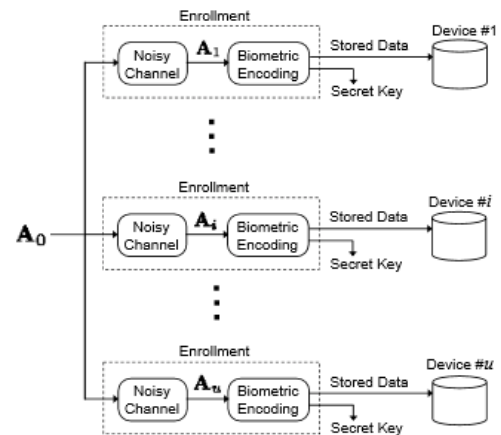

Fig. 1. Noisy measurements  $A_1, \dots, A_u$  of a user's underlying biometric  $A_0$  are encoded at each access control device to generate authentication data, which is stored in the device, and a secret key. Our goal is to analyze the tradeoffs between authentication performance and information leakage from compromised stored authentication data and secret keys.

## Analysis of 3D and Multiview Extensions of the Emerging HEVC Standard

Citation: Vetro, A.; Tian, D., “Analysis of 3D and Multiview Extensions of the Emerging HEVC Standard”, *SPIE Conference on Applications of Digital Image Processing*, Paper 8499-33, August 2012

Contacts: Anthony Vetro, Dong Tian

Standardization of a new set of 3D formats has been initiated with the goal of improving the coding of stereo and multiview video, and also facilitating the generation of multiview output needed for auto-stereoscopic displays. Part of this effort will develop 3D and multiview extensions of the emerging standard for High Efficiency Video Coding (HEVC).

This paper outlines some of the key technologies and architectures being considered for standardization, and analyzes the viability, benefits and drawbacks of different codec designs.

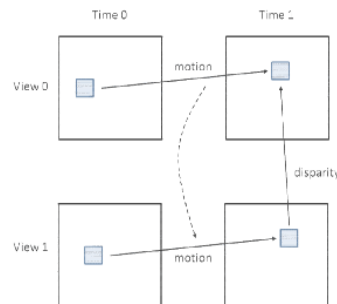

Figure 2. Illustration of motion prediction between views, where the motion vector of view 1 is inferred from the motion vector of view 0 from corresponding blocks at time 1 based on the disparity between those blocks.

## Pan-Sharpening with Multi-scale Wavelet Dictionary

Citation: Liu, D.; Boufounos, P.T, “Pan-Sharpening with Multi-scale Wavelet Dictionary”, IEEE International Geoscience and Remote Sensing Symposium (IGARSS), Paper TH2.5.2, July 2012  
 Contacts: Dehong Liu, Petros T. Boufounos

In satellite image processing, pan-sharpening is the image fusion process in which a low resolution (LR) multi-spectral (MS) image is sharpened using the corresponding high resolution (HR) panchromatic (Pan) image to obtain a HR MS image. In this paper we propose a novel pan-sharpening method that combines the ideas of classical wavelet-based pan-sharpening with recently developed dictionary learning (DL) methods. The HR MS image is generated using wavelet-based pan-sharpening, regulated by promoting sparsity with respect to a dictionary. The dictionary is obtained using DL on the multi-scale wavelet tree vectors of the image to be pan-sharpened. A significant advantage of our approach compared to most DL-based approaches is that it does not require a large database of images on which to train the dictionary.

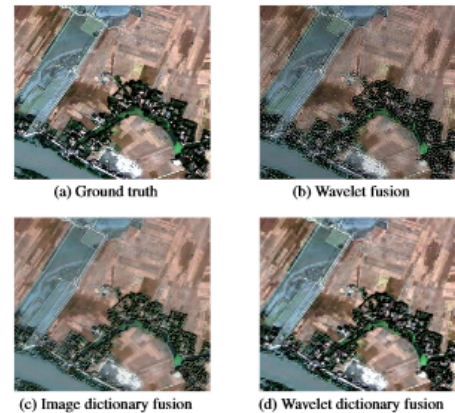

Fig. 2. (a) Ground truth and Pan-sharpened QuickBird images using (b) Wavelet fusion, (c) Image dictionary fusion, (d) Wavelet dictionary fusion.

## Predictive Coding of Intra Prediction Modes for High Efficiency Video Coding

Citation: Xu, X.; Cohen, R.A.; Vetro, A.; Sun, H., “Predictive Coding of Intra Prediction Modes for High Efficiency Video Coding”, Picture Coding Symposium (PCS), DOI: 10.1109/PCS.2012.6213253, pp. 457-460, May 2012  
 Contacts: Robert A. Cohen, Huifang Sun, Anthony Vetro

The High Efficiency Video Coding (HEVC) standardization process currently underway includes many tools for the coding of intra pictures. HEVC allows for many more intra prediction modes or directions as compared to previous standards. Efficient coding of these modes is therefore important because the modes consume a non-negligible portion of the total bit-stream used for coding intra pictures. In this paper, a predictive coding method is proposed to reduce the number of bits needed for signaling the intra prediction modes, where the spatial angular correlation between the intra prediction mode of the current Prediction Unit (PU) and the neighboring PUs is computed using a few modulo-N arithmetic operations that do not impact encoder or decoder run-times.

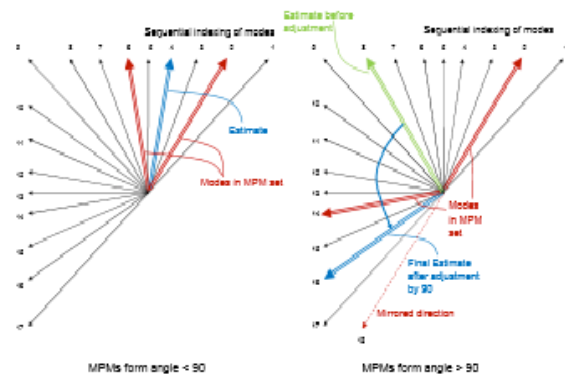

Fig. 3. Generation of predictor for the current intra prediction mode

## Consistent Wiener Filtering for Audio Source Separation

Citation: Le Roux, J.; Vincent, E., “Consistent Wiener Filtering for Audio Source Separation”, IEEE Signal Processing Letters, DOI: 10.1109/LSP.2012.2225617, Vol. 20, No. 3, pp. 217-220, March 2013  
 Contacts: Jonathan Le Roux

Wiener filtering is one of the most ubiquitous tools in signal processing, in particular for signal denoising and source separation. In the context of audio, it is typically applied in the time-frequency domain by means of the short-time Fourier transform (STFT). Such processing does generally not take into account the relationship between STFT coefficients in different time-frequency bins due to the redundancy of the STFT, which we refer to as consistency. We propose to enforce this relationship in the design of the Wiener filter, either as a hard constraint or as a soft penalty. We derive two conjugate gradient algorithms for the computation of the filter coefficients and show improved audio source separation performance compared to the classical Wiener filter both in oracle and in blind conditions.

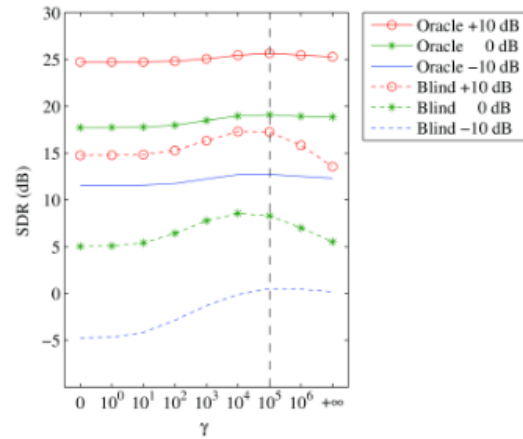

Fig. 2. Output SDR of the classical Wiener filter ( $\gamma = 0$ ) and the proposed constraint-based ( $\gamma = +\infty$ ) and penalty-based algorithms in oracle and blind conditions, averaged over all mixtures for each input SNR.

## Structured Discriminative Models for Speech Recognition

Citation: Gales, M.; Watanabe, S.; Fosler-Lussier, E., “Structured Discriminative Models for Speech Recognition”, IEEE Signal Processing Magazine, Vol. 29, Issue 6, pp. 70-81, November 2012  
 Contacts: Shinji Watanabe

Automatic Speech Recognition (ASR) systems classify structured sequence data, where the label sequences (sentences) must be inferred from the observation sequences (the acoustic waveform).

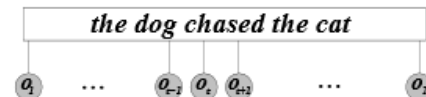

Fig. 2. Graphical model for a simple discriminative model

The sequential nature of the task is one of the reasons why generative classifiers, based on combining hidden Markov model (HMM) acoustic models and N-gram language models using Bayes' rule, have become the dominant technology used in ASR. Conversely, the machine learning and natural language processing (NLP) research areas are increasingly dominated by discriminative approaches, where the class posteriors are directly modeled. This paper describes recent work in the area of structured discriminative models for ASR. To handle continuous, variable length, observation sequences, the approaches applied to NLP tasks must be modified. This paper discusses a variety of approaches for applying structured discriminative models to ASR, both from the current literature and possible future approaches. We concentrate on structured models themselves, the descriptive features of observations commonly used within the models, and various options for optimizing the parameters of the model.

## Factorial Models for Noise Robust Speech Recognition

Citation: Hershey, J.R.; Rennie, S.J.; Le Roux, J., “Factorial Models for Noise Robust Speech Recognition”, *Technique for Noise robustness in Automatic Speech Recognition*, Chapter 12, November 2012

Contacts: John R. Hershey, Jonathan Le Roux

Noise compensation techniques for robust automatic speech recognition (ASR) attempt to improve system performance in the presence of interference from acoustic signals in the environment other than the speech being recognized. In feature-based noise compensation, which includes speech enhancement, the features extracted from the noisy speech signal are modified before being sent to the recognizer by attempting to remove the effects of noise on the speech features.

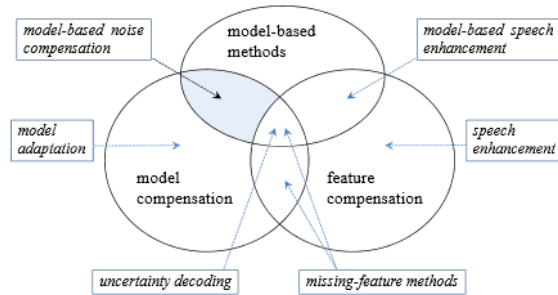

**Figure 12.1** Noise compensation methods in a Venn diagram. The shaded region represents model-based noise compensation, the subject of this chapter. Note that the term “model” in “model compensation” refers to the recognizer’s acoustic model, whereas in “model-based noise compensation,” it refers to the models of additive noise.

These methods are discussed in Chapter 12. Model compensation approaches, in contrast, are concerned with extending the acoustic model of speech to account for the effects of noise. A taxonomy of different approaches to noise compensation is depicted in Figure 1.1, which serves as a road map to the present discussion.

## Indirect Model-Based Speech Enhancement

Citation: Le Roux, J.; Hershey, J.R., “Indirect Model-based Speech Enhancement”, *IEEE International Conference on Acoustics, Speech and Signal Processing (ICASSP)*, pp. 4045-4048, March 2012

Contacts: Jonathan Le Roux, John R. Hershey

Model-based speech enhancement methods, such as vector-Taylor series-based methods (VTS) [1, 2], share a common methodology: they estimate speech using the expected value of the clean speech given the noisy speech under a statistical model. We show that it may be better to use the expected value of the noise under the model and subtract it from the noisy observation to form an indirect estimate of the speech. Interestingly, for VTS, this methodology turns out to be related to the application of an SNR-dependent gain to the direct VTS speech estimate. In results obtained on an automotive noise task, this methodology produces an average improvement of 1.6 dB signal-to-noise ratio (SNR), relative to conventional methods.

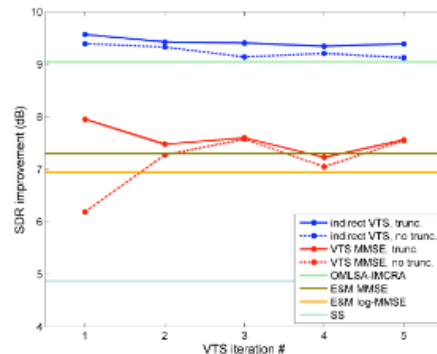

**Fig. 1.** Evolution of the SDR improvement depending on the VTS iteration number for the VTS MMSE and the speech obtained from the noise MMSE (indirect VTS), with and without truncation to the interaction function. Average SDR improvements for classical algorithms are shown for comparison.

# Data Analytics

Data Analytics technologies aim to improve the performance of devices, systems, and business processes by means of collecting data, constructing predictive models from that data, and making improved decisions based on the constructed models. The Data Analytics group at MERL has been working on both predictive and decision analytics, as well as supporting fields such as signal processing, numerical methods, and information systems infrastructure. The focus of the group is on innovative high-performance algorithms that can be applied to various product lines of Mitsubishi Electric, including electrical power systems, various transportation systems (trains, elevators, car navigation), heating, ventilation, and air conditioning (HVAC) systems and solutions, and factory automation. The application of these algorithms minimizes costs, maximizes profits, increases reliability, improves energy efficiency, and reduces environmental impact of products.

Research on predictive analytics supported by advances in the field of statistical machine learning aims to create accurate data-driven models of electromechanical and thermo dynamical systems as well as models of complex natural and man-made phenomena such as road traffic and demand for electrical power.

Decision optimization research emphasizes numerical methods for fast solution of network problems and finds application in the analysis of electrical power systems and Smart Grids that include renewable power sources with intermittent output as well as highly variable loads such as electrical vehicles. Many problems in transportation systems such as train operation optimization, group elevator scheduling, and route guidance for car navigation, can be reduced to planning and optimization problems. Energy consumption in buildings can be minimized by solving sequential decision and optimization problems, both at the level of individual air conditioning devices, as well as at the level of entire buildings.

## Recent Research

Decoupled Three-Phase Load Flow Method for Unbalanced Distribution Systems .....	52
Markov Decision Processes for Train Run Curve Optimization .....	52
Hybrid Three-Phase Load Flow Method for Ungrounded Distribution Systems .....	53
Global Optimization of Optimal Power Flow Using a Branch & Bound Algorithm .....	53
Fast Refrigerant Property Calculations Using Interpolation-Based Methods.....	54
Bayesian Networks for Matcher Composition in Automatic Schema Matching.....	54
Visualizing Set-valued Attributes in Parallel with Equal-height Histograms .....	55
Two-Level State Estimation Method for Power Systems with SCADA and PMU .....	55
Fast Runcurve Optimization based on Markov Decision Process .....	56
Envisioning Grid Vulnerabilities: Multi-dimensional Visualization for Electrical Grid .....	56
Construction of Embedded Markov Decision Processes for Optimal Control ... ..	57
State-space Approximate Dynamic Programming for Stochastic Unit Commitment .....	57
A Fast and Robust Load Flow Method for Distribution Systems .....	58
Development of a System for Power Theft Detection Using Smart Meters.....	58

## Decoupled Three-Phase Load Flow Method for Unbalanced Distribution Systems

Citation: Sun, H.; Dubey, A.; Nikovski, D.N.; Ohno, T.; Takano, T.; Kojima, Y., “Decoupled Three-Phase Load Flow Method for Unbalanced Distribution Systems”, *IEEE International Conference on Power Systems Technology (POWERCON)*, October 2012

Contacts: Hongbo Sun, Daniel N. Nikovski

This paper proposes a decoupled three-phase load flow analysis method for unbalanced distribution systems. The power flows are solved through nodal current injection mismatch equations written in rectangular coordinates. The method determines voltage changes resulting from conductance and susceptance matrices respectively, and determines the voltages of a node as a linear combination of those voltage changes. The constant active power and voltage magnitude (PV) nodes have been converted into constant active and reactive power (PQ) ones based on a sensitivity matrix determined through Kron reduction of the nodal admittance matrix, and the corresponding reactive powers are adjusted after each solution has converged. The zero-impedance branches are merged with adjacent impedance branches, and the three phases of a balanced-voltage PV bus are merged into one single-phase PV bus to be modeled in the nodal admittance matrix.

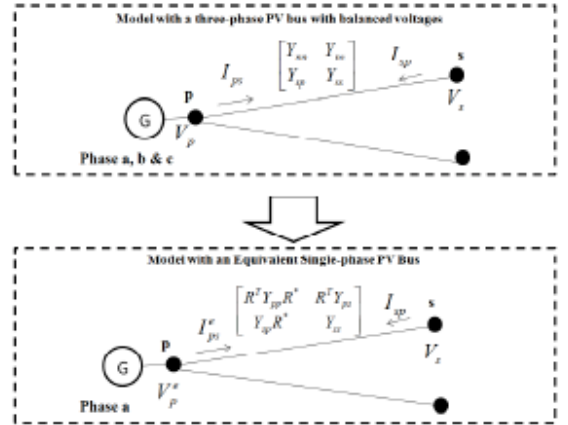

Fig.2. An Equivalent Model of Three-phase PV bus with balanced Voltages

## Markov Decision Processes for Train Run Curve Optimization

Citation: Nikovski, D.N.; Lidicky, V.; Zhang, W.; Kataoka, K.; Yoshimoto, K., “Markov Decision Processes for Train, Run Curve Optimization”, *Electrical Systems for Aircraft, Railway and Ship Propulsion (ESARS)*, ISSN: 2165-9400, pp. 1-6, October, 2012

Contacts: Daniel N. Nikovski, Kenji Kataoka

We propose three computationally efficient methods for finding optimal run curves of electrical trains, all based on the idea of approximating the continuous dynamics of a moving train by a Markov Decision Process (MDP) model. Deterministic continuous train dynamics are converted to stochastic transitions on a discrete model by observing the similarity between the properties of convex combinations and those of probability mass functions. The resulting MDP uses barycentric coordinates to effectively represent the cost-to-go of the approximated optimal control problem.

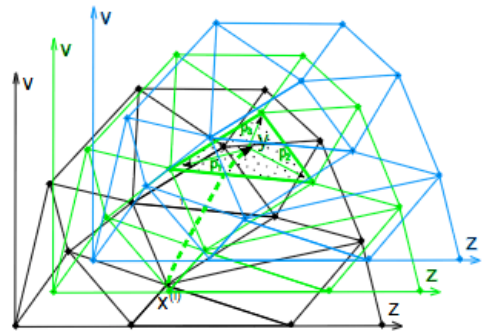

Figure V.1. The MDP for the fixed-end-time version of the problem has a separate replica of the triangulation for multiple time steps, organized into time slices. Three slices are shown here, in black, green, and blue, respectively. Each transition is from one time slice to the next (here, a transition is shown from  $x^{(t)}$  in the black slice to  $y$  in the green slice).



## Hybrid Three-Phase Load Flow Method for Ungrounded Distribution Systems

Citation: Sun, H.; Nikovski, D.N.; Ohno, T.; Takano, T.; Kojima, Y., “Hybrid Three-Phase Load Flow Method for Ungrounded Distribution Systems”, *IEEE PES Innovative Smart Grid Technologies Europe (ISGT Europe)*, October 2012

Contacts: Hongbo Sun, Daniel N. Nikovski

This paper proposes a hybrid three-phase load flow method for ungrounded distribution systems. Based on topology connectivity analysis, the system is partitioned into a mainline system and multiple tap systems. A Newton method with constant admittance matrix is used to solve the mainline system, such that zero impedance branches are merged into adjacent impedance branches to be considered, and constant active-power and voltage-magnitude (PV) buses with three-phase balanced voltages are transformed into single-phase PV buses to be modeled. A backward/forward sweep with loop compensation is used to solve the tap systems, such that a transformer and a voltage regulator is modeled using line-to-line voltages, a distribution line is simplified as a series branch, and loop compensation current is initialized based on loop downstream loads and the impedances of loop paths.

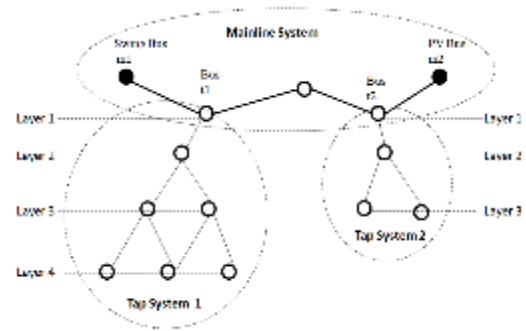

Fig. 1 Distribution system partitioning

## Global Optimization of Optimal Power Flow Using a Branch & Bound Algorithm

Citation: Gopalakrishnan, A.; Raghunathan, A.U.; Nikovski, D.; Biegler, L.T., “Global Optimization of Optimal Power Flow Using a Branch & Bound Algorithm”, *Allerton Conference on Communication, Control, and Computing*, October 2012

Contacts: Arvind U. Raghunathan, Daniel N. Nikovski

We propose two algorithms for the solution of the Optimal Power Flow (OPF) problem to global optimality. The algorithms are based on the spatial branch and bound framework with lower bounds on the optimal objective function value calculated by solving either the Lagrangian dual or the semidefinite programming (SDP) relaxation. We show that this approach can solve to global optimality the general form of the OPF problem including: generation power bounds, apparent and real power line limits, voltage limits and thermal loss limits. The approach makes no assumption on the topology or resistive connectivity of the network. We present the performance of the algorithms on a number of standard IEEE systems, which are known to have a zero duality gap.

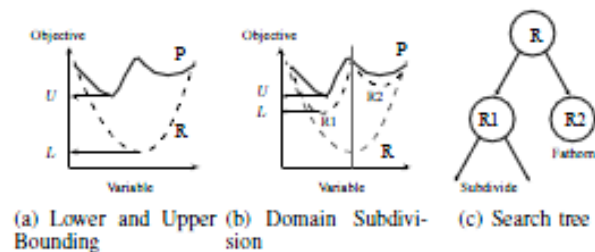

Fig. 1: Branch and Bound Schematic

## Fast Refrigerant Property Calculations Using Interpolation-Based Methods

Citation: Laughman, C.R.; Zhao, Y.; Nikovski, D.N, “Fast Refrigerant Property Calculations Using Interpolation-Based Methods”, *International Refrigeration and Air Conditioning Conference at Purdue*, July 2012

Contacts: Christopher R. Laughman, Daniel N. Nikovski, Yiming Zhao

An interpolation-based method for computing refrigerant properties which can be used in simulations of vapor-compression air-conditioning equipment is presented. This method uses bicubic functions to interpolate between samples of the Helmholtz energy surface as a function of temperature and density. Three beneficial characteristics of this method are discussed: speed, accuracy, and consistency, as well as a means for using a variety of different independent variables are also presented. The implementation of this method is discussed, and experimental results for property calculations for refrigerant R-134a are presented which compare favorably to standard Newton-based equation of state methods.

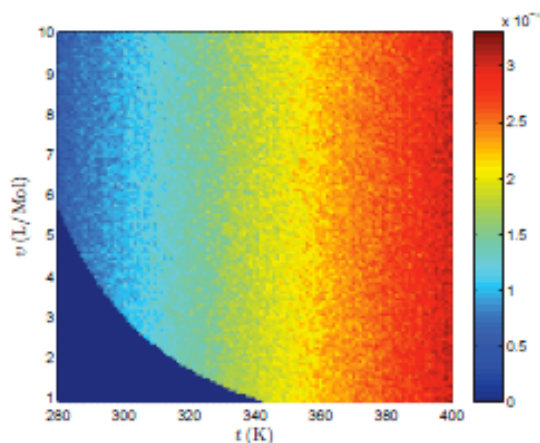

Figure 2: Computation consistency error:  $E_t$ .

## Bayesian Networks for Matcher Composition in Automatic Schema Matching

Citation: Nikovski, D.N.; Esenther, A.W.; Ye, X.; Shiba, M.; Takayama, S., “Bayesian Networks for Matcher Composition in Automatic Schema Matching”, *International Conference on Enterprise Information Systems (ICEIS)*, Vol. 1, pp. 48-55, June 2012

Contacts: Daniel N. Nikovski, Alan W. Esenther

We propose a method for accurate combining of evidence supplied by multiple individual matchers regarding whether two data schema elements match (refer to the same object or concept), or not, in the field of automatic schema matching. The method uses a Bayesian network to model correctly the statistical correlations between the similarity values produced by individual matchers that use the same or similar information, in order to avoid overconfidence in match probability estimates and improve the accuracy of matching. Experimental results under several testing protocols suggest that the matching accuracy of the Bayesian composite matcher can significantly exceed that of the individual component matchers.

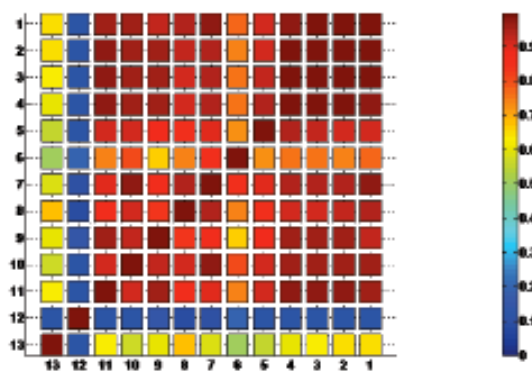

Figure 2: Pair-wise correlations between all pairs of basic matchers, numbered as follows: 1: Edit Distance; 2: Sub-string Distance; 3: Bi-Gram Distance; 4: Tri-Gram Distance; 5: Quad-Gram Distance; 6: Cosine Similarity; 7: Hamming Distance; 8: Jaro Measure; 9: Affix Name; 10: Prefix Name; 11: Suffix Name; 12: Path Name; 13: Synonym.

## Visualizing Set-valued Attributes in Parallel with Equal-height Histograms

Citation: Wittenburg, K.B.; Malizia, A.; Lupo, L.; Pekheteryev, G., “Visualizing Set-valued Attributes in Parallel with Equal-height Histograms”, *International Working Conference on Advanced Visual Interfaces (AVI)*, ISBN: 978-1-4503-1287-5, pp. 632-635, May 2012

Contacts: Kent B. Wittenburg

Visualization of set-value attributes in multi-dimensional information visualization systems remains a relatively unexplored problem. Here we introduce a novel method for visualizing set-value attributes that we call the singleton set distribution view and integrate it into an interactive multi-dimensional attribute visualization tool utilizing parallel bargrams (aka equal-height histograms) as its main visual motif. We discuss our design rationale and report on the results of an evaluation study.

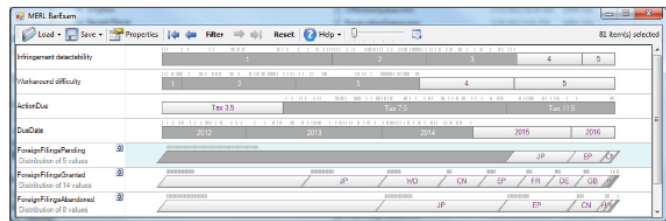

Figure 5. Use case involving reducing maintenance fees in the management of a patent portfolio. The user has already filtered a much larger set of patents to those that require maintenance. Now the user is exploring constraining the set further with the goal of ending up with a short list that can be examined in more detail.

## Two-Level State Estimation Method for Power Systems with SCADA and PMU Measurements

Citation: Sun, H.; Wang, Z.; Nikovski, D.N., “Two-Level State Estimation Method for Power Systems with SCADA and PMU Measurements”, *IEEE Innovative Smart Grid Technologies-Asia (ISGT Asia)*, DOI: 10.1109/ISGT-Asia.2012.6303127, pp. 1-5, May 2012

Contacts: Hongbo Sun, Daniel N. Nikovski

This paper proposes a two-level hybrid state estimation method for power systems with SCADA and PMU measurements. A power system is decoupled into PMU observed areas and SCADA observed areas based on its system measurement configuration and topology connectivity, and the states of areas are solved by a two-level computational procedure. The first level uses PMU measurements and pseudo measurements derived from SCADA measurements to formulate a linear state estimation model for each PMU observed area, from which the states of the buses in the area are estimated. The second level uses the SCADA measurements and pseudo measurements generated by results at the first level to formulate a nonlinear state estimation model for each SCADA observed area. The weighted least square method is used to solve the models at the two levels. Test results on an IEEE 14 bus system and an IEEE 118 bus system are given to demonstrate the effectiveness of the proposed method.

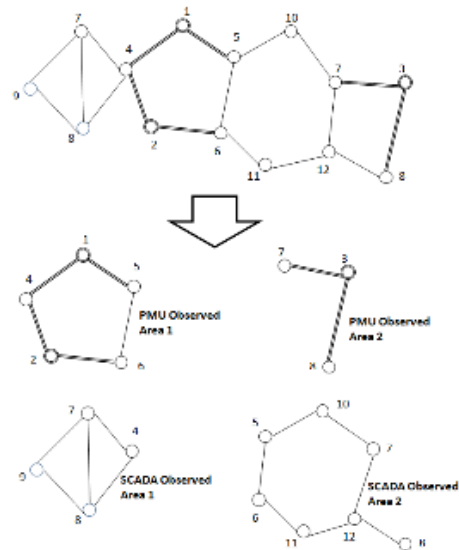

Fig. 1. PMU and SCADA Observed Areas

## Fast Runcurve Optimization based on Markov Decision Process

Citation: Fujii, S.; Yoshimoto, K.; Ueda, K.; Takahashi, S.; Nikovski, D.N., “Fast Runcurve Optimization based on Markov Decision Process”, *Symposium of the Society of Instrumentation and Control Engineers of Japan (SICE)*, January 2013

Contacts: Daniel N. Nikovski

This paper proposes a fast algorithm to solve runcurve optimization problem. We model the problem with Markov decision process in which cost function is defined by a weighted sum of energy consumption and running time, select appropriate weight values, and compute optimal runcurve with dynamic programming. We have confirmed that the proposed algorithm could optimize runcurve of 2,000m within around 1 sec by simulation results.

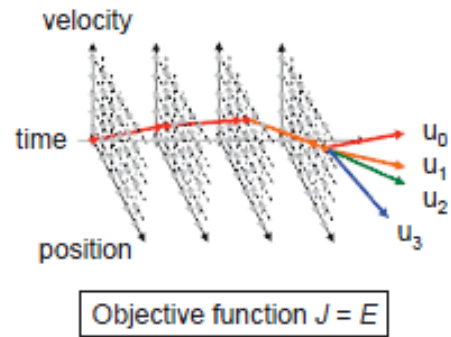

## Envisioning Grid Vulnerabilities: Multi-dimensional Visualization for Electrical Grid Planning

Citation: Romero, R.; Diez, D.; Wittenburg, K.; Diaz, P., “Envisioning Grid Vulnerabilities: Multi-dimensional Visualization for Electrical Grid Planning”, *International Working Conference on Advanced visual Interfaces (AVI)*, ISBN: 978-1-4503-1287-5, pp. 701-704, May 2012

Contacts: Kent B. Wittenburg

Electrical grid planning aims at optimizing the grid through the control of the performance and placement of electrical assets in order to minimize failures or vulnerabilities. With this purpose, grid planners carry out an initial stage of data



Figure 4. Screen shot of BarExam software. View is filtered following Figure 3 selections. Detailed view of the Element\_code dimension shows co-occurrence through vertical alignment with the elements ordered by frequency.

exploration using a large volume of incident and equipment data collected over extensive time periods. In current practice these tasks are performed manually, which makes it very difficult to recognize patterns and gain insights into the data. In this paper, we propose a parallel multivariate visualization technique as a suitable approach for improving the existing practice. Based on the usage of an interactive visualization tool called BarExam, we demonstrate the feasibility of this visualization technique for displaying the dataset and present example insights that this visualization techniques can provide to grid planners.

## Construction of Embedded Markov Decision Processes for Optimal Control of Non-Linear Systems with Continuous State Spaces

Citation: Nikovski, D.; Esenther, A., "Construction of Embedded Markov Decision Processes for Optimal Control of Non-Linear Systems with Continuous State Spaces", *IEEE Conference on Decision and Control and European Control Conference (CDC-ECC)*, DOI: 10.1109/CDC.2011.6161310, pp. 7944-7949, December 2011

Contacts: Daniel N. Nikovski, Alan W. Esenther

We consider the problem of constructing a suitable discrete-state approximation of an arbitrary non-linear dynamical system with continuous state space and discrete control actions that would allow close to optimal sequential control of that system by means of value or policy iteration on the approximated model. We propose a method for approximating the continuous dynamics by means of an embedded Markov decision process (MDP) model defined over an arbitrary set of discrete states sampled from the original continuous state space. The mathematical similarity between sets of barycentric coordinates (convex combination) and probability mass functions is exploited to compute the transition matrices and initial state distribution of the MDP.

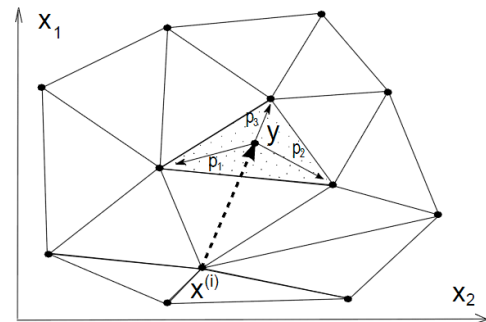

## State-space Approximate Dynamic Programming for Stochastic Unit Commitment

Citation: Zhang, W.; Nikovski, D., "State-space Approximate Dynamic Programming for Stochastic Unit Commitment", *North American Power Symposium (NAPS)*, DOI: 10.1109/NAPS.2011.6025113, pp. 1-7, August 2011

Contacts: Daniel N. Nikovski

It is known that unit commitment problems with uncertainties in power demands and the outputs of some generators can be represented as factored Markov decision process models. In this paper we propose a state space approximate dynamic programming algorithm to solve such models. The algorithm features a method to generate representative system configurations (states) and a functional metric to measure the similarity among system configurations. Experimental results show that the algorithm outperforms two deterministic approaches in resulting in both lower risks and operational costs, and that it can solve larger problems than a stochastic approach based on decision space approximate dynamic programming.

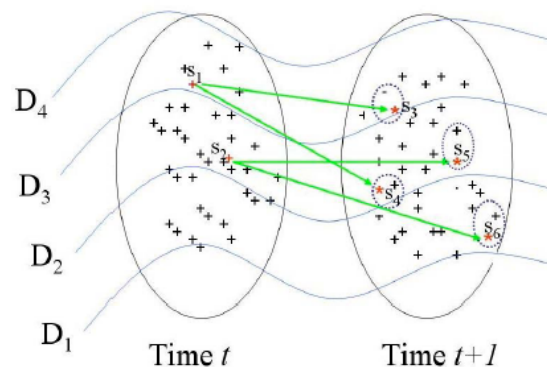

## A Fast and Robust Load Flow Method for Distribution Systems with Distributed Generations

Citation: Sun, H.; Nikovski, D.; Ohno, T.; Takano, T.; Kojima, Y., "A Fast and Robust Load Flow Method for Distribution Systems with Distributed Generations", *IEEE International Conference on Smart Grid and Clean Energy Technologies (ICSGCE)*, September 2011

Contacts: Hongbo Sun, Daniel N. Nikovski

This paper proposes a fast and robust load flow method for balanced power distribution systems with distributed generation sources. The method formulates generation sources. The method formulates the power flow equations in PQ decoupled form with polar coordinates. Second-order terms are included in the active power mismatch iteration, and resistances are fully modeled without any simplifications. The impacts of zero-impedance branches are explicitly modeled through reconfiguring of the adjacent branches with impedances. Typical distribution generation models and distribution load models are included. A hybrid direct and indirect solution technique is used to achieve efficiency and robustness of the algorithm. Active power correction is solved by means of a sparse LU decomposition algorithm with partial pivoting, and the reactive power correction is solved by means of restarted Generalized Minimal Residual algorithm with incomplete LU pre-conditioner. The numerical examples on a sample distribution system with widespread Photovoltaic installations are given to demonstrate the effectiveness of the proposed method.

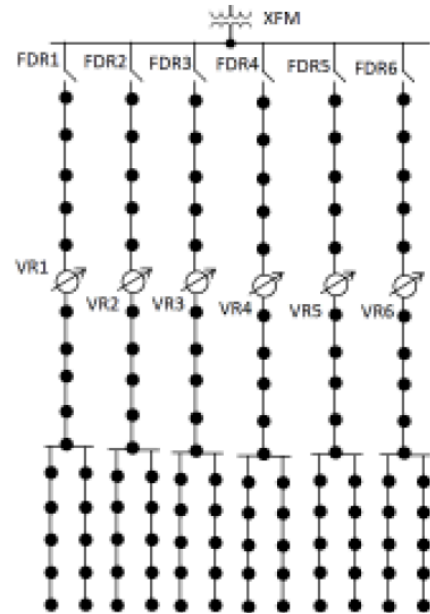

## Development of a System for Power Theft Detection Using Smart Meters

Citation: Sugiura, K.; Muso, T.; Tsuni, K.; Nikovski, D.N.; Esenther, A.W.; Sun, H., "Development of a System for Power Theft Detection Using Smart Meters", *IPSSJ National Convention of the Information Processing Society of Japan*, March 2013

Contacts: Daniel N. Nikovski, Alan W. Esenther, Hongbo Sun

We propose a method and system for detection of power theft based on a procedure for estimating technical losses in distribution networks from information about power demand from households and power supply from distribution transformers. This system makes it possible to detect power theft that has been impossible to detect so far. The effectiveness of this system will be verified on real power consumption data.

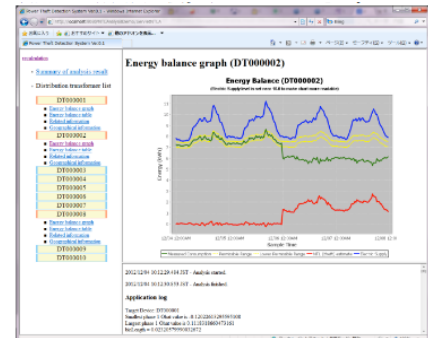

# Imaging

The research in the Imaging group at MERL covers all aspects of extracting information from images. For instance, from a picture of a scene we can compute features that allow the detection and location of specific objects. Or we learn a dictionary for the appearance of local patches in an image and use it to classify regions and objects or to improve the image quality. We can track a moving object in video to quantify its trajectory. In some cases we can modify the actual image creation process to make subsequent information extraction more effective. For instance, multiple flash exposures can be used to identify an object's edges.

Several of our current projects involve 3D analysis based on 2D images. For example, we have developed algorithms for estimation of object pose so that a robot arm can grasp an object from a cluttered workspace. In another project, we infer automobile position in a city through matching of camera images to a 3D city model. For medical radiation treatment, we align patient position by matching current x-rays to simulated x-rays obtained by project. In all these cases, the algorithms we have developed must be very fast and accurate. We have also developed algorithms that operate directly on 3D data for reconstruction, detection, and recognition.

For several years, MERL has been a leader in computational photography and imaging. Given that many images are now computer processed prior to viewing, this research seeks to modify the capture stage to optimize the information transfer into the computer and ultimately into the final usage—perhaps human viewing, or perhaps more computer analysis to extract quantitative measures from the image. In this research MERL has been able to dramatically improve corrections for motion and focus blur, achieve spatial and temporal super-resolution in video, and conceive novel camera optics for wide field of view stereo reconstruction.

## Recent Research

Fast Object Localization and Pose Estimation in Heavy Clutter for Robotic Bin Picking.....	60
Monocular Visual Odometry and Dense 3D Reconstruction for On-Road Vehicles .....	60
Rao-Blackwellized Particle Filtering for Probing-Based 6-DOF Localization in Robotic ... ..	61
SLAM Using Both Points and Planes for Hand-Held 3D Sensors .....	61
Learning on Manifolds.....	62
A Theory of Minimal 3D Point to 3D Plane Registration and Its Generation.....	62
A Theory of Multi-Layer Flat Refractive Geometry .....	63
Sensor Placement Tool for Rapid Development of Video Sensor Layouts.....	63
Find a Needle in a Specular Haystack .....	64
Voting-based Pose Estimation for Robotic Assembly Using a 3D Sensor.....	64
Concentric Ring Signature Descriptor for 3D Objects .....	65
Pose Normalization via Learned 2D Warping for Fully Automatic Face Recognition .....	65
Pose Estimation using Both Points and Lines for Geo-Localization .....	66
Entropy Rate Superpixel Segmentation .....	66

## Fast Object Localization and Pose Estimation in Heavy Clutter for Robotic Bin Picking

Citation: Liu, M.-Y.; Tuzel, O.; Veeraraghavan, A.; Taguchi, Y.; Marks, T.K.; Chellappa, R., “Fast Object Localization and Pose Estimation in Heavy Clutter for Robotic Bin Picking”, *The International Journal of Robotics Research*, May 2012

Contacts: Ming-Yu Liu, Tim K. Marks, Yuichi Taguchi, C. Oncel Tuzel

We present a practical vision-based robotic bin-picking system that performs detection and 3D pose estimation of objects in an unstructured bin using a novel camera design, picks up parts from the bin, and performs error detection and pose correction while the part is in the gripper. Two main innovations enable our system to achieve real-time robust and accurate operation. First, we use a multi-flash camera that extracts robust depth edges. Second, we introduce an efficient shape-matching algorithm called fast directional chamfer matching (FDCM), which is used to reliably detect objects and estimate their poses. FDCM improves the accuracy of chamfer matching by including edge orientation. It also achieves massive improvements in matching speed using line-segment approximations of edges, a 3D distance transform, and directional integral images. FDCM is up to two orders of magnitude faster than the previous methods.



## Monocular Visual Odometry and Dense 3D Reconstruction for On-Road Vehicles

Citation: Zhu, M.; Ramalingam, S.; Taguchi, Y.; Garaas, T.W., “Monocular Visual Odometry and Dense 3D Reconstruction for On-Road Vehicles”, *European Conference on Computer Vision (ECCV)*, Vol. 7584, 2012, pp. 596-606, October 2012

Contacts: Srikumar Ramalingam, Tyler W. Garaas, Yuichi Taguchi

More and more on-road vehicles are equipped with cameras each day. This paper presents a novel method for estimating the relative motion of a vehicle from a sequence of images obtained using a single vehicle-mounted camera. In this paper, we show that the planar 2-point motion estimation can be solved analytically using a single quadratic equation. Although 2-point motion estimation generates visually accurate on-road vehicle-trajectory, the motion is not precise enough to perform dense 3D reconstruction due to the non-planarity of roads. Thus we use a 2-point relative motion algorithm for the initial images followed by 3-point 2D-to-3D camera pose estimation for the subsequent images. Using this hybrid approach, we generate accurate motion estimates for a plane-sweeping algorithm that produces dense depth maps for obstacle detection applications.

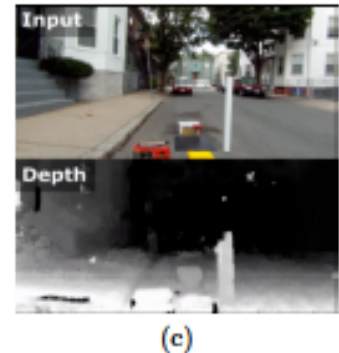



## Rao-Blackwellized Particle Filtering for Probing-Based 6-DOF Localization in Robotic Assembly

Citation: Taguchi, Y.; Marks, T.K.; Okuda, H., "Rao-Blackwellized Particle Filtering for Probing-based 6-DOF Localization in Robotic Assembly", *IEEE International Conference on Robotics and Automation (ICRA)*, ISSN: 105-4729, pp. 2610-2617, Best Automation Paper Award Finalist, May 2010

Contacts: Yuchi Taguchi, Tim Marks

This paper presents a probing-based method for probabilistic localization in automated robotic assembly. We consider peg-in-hole problems in which a needle-like peg has a single point of contact with the object that contains the hole, and in which the initial uncertainty in the relative pose (3D position and 3D angle) between the peg and the object is much greater than the required accuracy (assembly clearance). We solve this 6 degree-of-freedom (6-DOF) localization problem using a Rao-Blackwellized particle filter, in which the probability distribution over the peg's pose is factored into two components: The distribution over position (3-DOF) is represented by particles, while the distribution over angle (3-DOF) is approximated as a Gaussian distribution for each particle, updated using an extended Kalman filter. This factorization reduces the number of particles required for localization by orders of magnitude, enabling real-time online 6-DOF pose estimation.

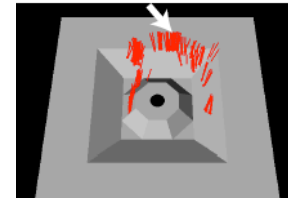

## SLAM Using Both Points and Planes for Hand-Held 3D Sensors

Citation: Taguchi, Y.; Jian, Y.-D.; Ramalingam, S.; Feng, C., "SLAM Using Both Points and Planes for Hand-Held 3D Sensors", *International Symposium on Mixed and Augmented Reality (ISMAR)*, November 2012

Contacts: Yuichi Taguchi, Srikumar Ramalingam

We present a simultaneous localization and mapping (SLAM) algorithm for a hand-held 3D sensor that uses both points and planes as primitives. Our algorithm uses any combination of three point/plane primitives (3 planes, 2 planes and 1 point, 1 plane and 2 points, and 3 points) in a RANSAC framework to efficiently compute the sensor pose. As the number of planes is significantly smaller than the number of points in typical 3D scenes, our RANSAC algorithm prefers primitive combinations involving more planes than points. In contrast to existing approaches that mainly use points for registration, our algorithm has the following advantages: (1) it enables faster correspondence search and registration due to the smaller number of plane primitives; (2) it produces plane based 3D models that are more compact than point-based ones; and (3) being a global registration algorithm, our approach does not suffer from local minima or any initialization problems.

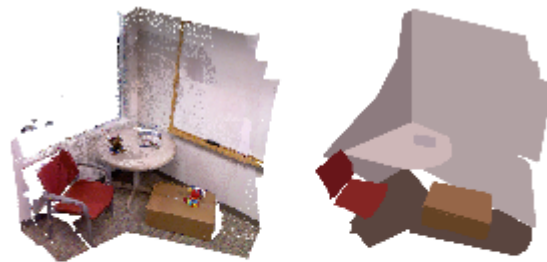

Figure 1: A 3D model reconstructed from a sequence in Figure 3. Our system not only generates registered 3D point clouds (left), but also reconstructs a scene as a set of planes (right). Note that the plane-based representation is obtained from plane landmarks, generated in our real-time SLAM algorithm (not in post-processing). In this model, the number of keyframes registered is 39, and the numbers of point and plane landmarks are 6912 and 9, respectively.

## Learning on Manifolds

Citation: Porikli, F., "Learning on Manifolds", *Joint IAPR International Conference on Structural, Syntactic and Statistical Pattern Recognition (SSPR & SPR)*, August 2010

Contacts: Fatih Porikli

Mathematical formulation of certain natural phenomena exhibits group structure on topological spaces that resemble the Euclidean space only on a small enough scale, which prevents incorporation of conventional inference methods that require global vector norms. In computer vision, such underlying notions emerge in differentiable parameter spaces. Here, two Riemannian manifolds including the set of affine transformations and covariance matrices are elaborated and their favorable applications in distance computation, motion estimation, object detection and recognition problems are demonstrated after reviewing some of the fundamental preliminaries.

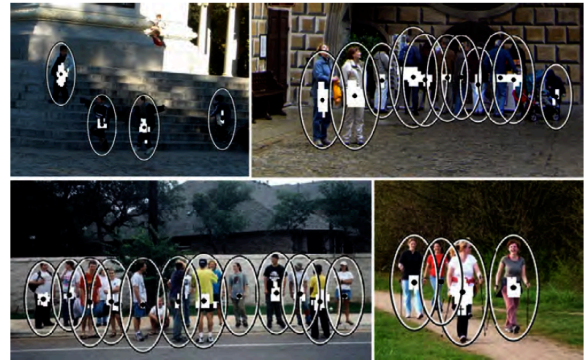

## A Theory of Minimal 3D Point to 3D Plane Registration and Its Generation

Citation: Ramalingam, S.; Taguchi, Y., "A Theory of Minimal 3D Point to 3D Plane Registration and Its Generalization", *International Journal of Computer Vision*, DOI: 10.1007/s11263-012-0476-x, September 2012

Contacts: Srikumar Ramalingam, Yuichi Taguchi

Registration of 3D data is a key problem in many applications in computer vision, computer graphics and robotics. This paper provides a family of minimal solutions for the 3D-to-3D registration problem in which the 3D data are represented as points and planes. Such scenarios occur frequently when a 3D sensor provides 3D points and our goal is to register them to a 3D object represented by a set of planes. In order to compute the 6 degrees-of-freedom transformation between the sensor and the object, we need at least six points on three or more planes. We systematically investigate and develop pose estimation algorithms for several configurations, including all minimal configurations that arise from the distribution of points on planes. We show that many 2D-to-3D and 3D-to-3D pose estimation/registration algorithms involving points, lines, and planes can be mapped to the proposed framework. We validate our theory in simulations as well as in three real-world applications: registration of a robotic arm with an object using a contact sensor, registration of planar city models with 3D point clouds obtained using multi-view reconstruction, and registration between depth maps generated by a Kinect sensor.

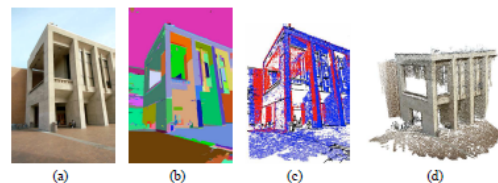

Fig. 7. Registering two point clouds, each generated by applying multi-view reconstruction techniques to 15 images. (a) One of the images used in 3D reconstruction. (b) superpixel segmentation of the image shown in (a). (c) The 3D points from the first (blue) and second (red) clouds are reprojected onto the superpixel image. The points from the first point cloud are used to compute the superpixel plane parameters, while the second point cloud is preserved as points. The correspondence between the points from the second cloud and the planes obtained from the first cloud are determined by the underlying superpixel. (d) 3D model after merging the two partial reconstructions from the two clusters. [Best viewed in color]

## A Theory of Multi-Layer Flat Refractive Geometry

Citation: Agrawal, A.; Ramalingam, S.; Taguchi, Y.; Chari, V., "A Theory of Multi-Layer Flat Refractive Geometry", *IEEE Conference on Computer Vision and Pattern Recognition (CVPR)*, pp. 3346-3353, June 2012

Contacts: Amit K. Agrawal, Srikumar Ramalingam, Yuichi Taguchi

Flat refractive geometry corresponds to a perspective camera looking through single/multiple parallel flat refractive mediums. We show that the underlying geometry of rays corresponds to an axial camera. This realization, missing from previous works, leads us to develop a general theory of calibrating such systems using 2D-3D correspondences. The pose of 3D points is assumed to be unknown and is also recovered. Calibration can be done even using a single image of a plane. We show that the unknown orientation of the refracting layers corresponds to the underlying axis, and can be obtained independently of the number of layers, their distances from the camera and their refractive indices. Interestingly, the axis estimation can be mapped to the classical essential matrix computation and the 5-point algorithm can be used. After computing the axis, the thicknesses of layers can be obtained linearly when refractive indices are known, and we derive analytical solutions when they are unknown.



Figure 6. (Left) Setup. (Right) Photo captured by looking through a water tank. Projected 3D points are overlaid by applying pose estimated using CA (green) and our algorithm (red).

## Sensor Placement Tool for Rapid Development of Video Sensor Layouts

Citation: Garaas, T.W., "Sensor Placement Tool for Rapid Development of Video Sensor Layouts", *Symposium on Simulation for Architecture and Urban Design (SimAUD)*, pp. 134-137, April 2011

Contacts: Tyler W. Garaas

The arrangement of video sensors—in closed circuit television (CCTV) systems, for instance—can have drastic effects on the efficiency and cost of the final system. In the present work, I describe a tool designed for rapid construction of simulated video sensor layouts that allows quantification of sensor coverage and cost estimation to be determined prior to installation; thus, avoiding costly changes during or after the installation. Most previous work in this area either considers sensor coverage only in a 2D space or requires significant preparation to achieve accurate results in 3D. In the present work, I describe an implementation of a novel coverage-analysis algorithm that uses the geometry of image formation to cast rays from simulated video sensors through the monitored area to estimate sensor coverage at every 3D location. Visualization techniques of the acquired sensor coverage data are additionally presented.

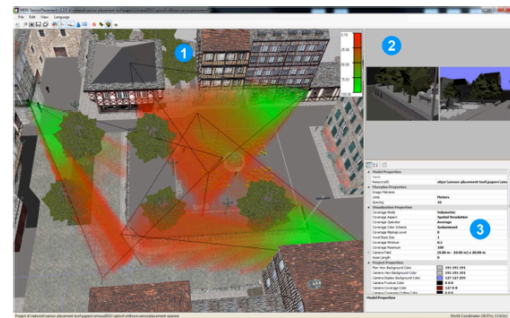

Figure 1. Illustration of the SPTopl GUI and the components that comprise it. Component 1 is the primary view window, where users interact with the environment and video sensors. Component 2 provides a virtual view from sensors within the environment. Finally, component 3 is a properties grid, where users can customize the parameters of selected 3D models, selected video sensors, environment parameters, or the sensor coverage analysis and visualization.

## Find a Needle in a Specular Haystack

Citation: Shroff, N.; Taguchi, Y.; Tuzel, O.; Veeraraghavan, A.; Ramalingam, S.; Okuda, H., "Finding a Needle in a Specular Haystack", *IEEE International Conference on Robotics and Automation (IRCA)*, DOI: 10.1109/ICRA.2011.5979857, pp. 5963-5970, May 2011

Contacts: Yuichi Taguchi, Takaaki Sakaguchi, C. Oncel Tuzel

Progress in machine vision algorithms has led to widespread adoption of these techniques to automate several industrial assembly tasks. Nevertheless, shiny or specular objects which are common in industrial environments still present a great challenge for vision systems. In this paper, we take a step towards this problem under the context of vision-aided robotic assembly. We show that when the illumination source moves, the specular highlights remain in a region whose radius is inversely proportional to the surface curvature. This allows us to extract regions of the object that have high surface curvature. These points of high curvature can be used as features for specular objects. Further, an inexpensive multi-flash camera (MFC) design can be used to reliably extract these features. We show that one can use multiple views of the object using the MFC in order to triangulate and obtain the 3D location and pose of the shiny objects. Finally, we show a system consisting of a robot arm with an MFC that can perform automated detection and pose estimation of shiny screws within a cluttered bin, achieving position and orientation errors less than 0.5 mm and 0.8 respectively.

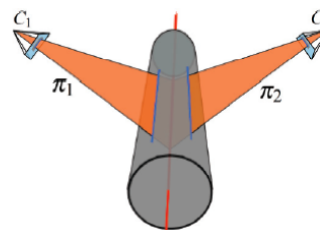

## Voting-based Pose Estimation for Robotic Assembly Using a 3D Sensor

Citation: Choi, C.; Taguchi, Y.; Tuzel, O.; Liu, M.-Y.; Ramalingam, S., "Voting-based Pose Estimation for Robotic Assembly Using a 3D Sensor", *IEEE International Conference on Robotics and Automation (ICRA)*, DOI: 10.1109/ICRA.2012.6225371, pp. 1724-1731, May 2012

Contacts: Yuichi Taguchi, Ming-Yu Liu, Srikumar Ramalingam, C. Oncel Tuzel

We propose a voting-based pose estimation algorithm applicable to 3D sensors. It was recently shown that a pair of oriented 3D points, which are points on the object surface with normals, in a voting framework enables fast and robust pose estimation. Although oriented surface points are discriminative for objects with sufficient curvature changes, they are not compact and discriminative enough for many industrial and real-world objects that are mostly planar. As edges play the key role in 2D registration, depth discontinuities are crucial in 3D. In this paper, we investigate and develop a family of pose estimation algorithms that better exploit this boundary information. In addition to oriented surface points, we use two other primitives: boundary points with directions and boundary line segments. Our experiments show that these carefully chosen primitives encode more information compactly and thereby provide higher accuracy for a wide class of industrial parts and enable faster computation.



## Concentric Ring Signature Descriptor for 3D Objects

Citation: Nguyen H.V.; Porikli, F., "Concentric Ring Signature Descriptor for 3D Objects", *IEEE International Conference on Image Processing (ICIP)*, DOI: 10.1109/ICIP.2011.6116153, September 2011

Contacts: Fatih M. Porikli

We present a 3D feature descriptor that represents local topologies within a set of folded concentric rings by distances from local points to a projection plane. This feature, called as Concentric Ring Signature (CORS), possesses similar computational advantages to point signatures yet provides more accurate matches. It produces more compact and discriminative descriptors than shape context. It is robust to noise and occlusions. As opposed to spin images, CORS does not require the point normal estimations; therefore it is directly applicable to sparse point clouds where the point densities are insufficiently low. Under the same settings, we demonstrate that the discriminative power of CORS is superior to conventional approaches producing twice as good estimates with the percentage of correct match scores improving from 39% to 88%.



Fig. 7. Top four retrieval results for a sample query of human object. CORS retrieves correct matches.

## Pose Normalization via Learned 2D Warping for Fully Automatic Face Recognition

Citation: Asthana, A.; Jones, M.J.; Marks, T.K.; Tieu, K.H.; Goecke, R., "Pose Normalization via Learned 2D Warping for Fully Automatic Face Recognition", *British Machine Vision Conference (BMVC)*, August 2011

Contacts: Michael J. Jones, Tim K. Marks

We present a novel approach to pose-invariant face recognition that handles continuous pose variations, is not database-specific, and achieves high accuracy without any manual intervention. Our method uses multi-dimensional Gaussian process regression to learn a nonlinear mapping function from the 2D shapes of faces at any non-frontal pose to the corresponding 2D frontal face shapes. We use this mapping to take an input image of a new face at an arbitrary pose and pose-normalize it, generating a synthetic frontal image of the face that is then used for recognition. Our fully automatic system for face recognition includes automatic methods for extracting 2D facial feature points and accurately estimating 3D head pose, and this information is used as input to the 2D pose-normalization algorithm. The current system can handle pose variation up to 45 degrees to the left or right (yaw angle) and up to 30 degrees up or down (pitch angle). The system demonstrates high accuracy in recognition experiments on the CMU-PIE, USF 3D, and Multi-PIE databases, showing excellent generalization across databases and convincingly outperforming other automatic methods.



Figure 3: Overview of our fully automatic pose-invariant face recognition system.

## Pose Estimation using Both Points and Lines for Geo-Localization

Citation: Ramalingam, S.; Bouazia, S.; Sturm, P., "Pose Estimation using Both Points and Lines for Geo-Localization", *IEEE International Conference on Robotics and Automation (ICRA)*, DOI: 10.1109/ICRA.2011.5979781, pp. 4716-4723, May 2011

Contacts: Srikumar Ramalingam

This paper identifies and fills the probably last two missing items in minimal pose estimation algorithms using points and lines. Pose estimation refers to the problem of recovering the pose of a calibrated camera given known features (points or lines) in the world and their projections on the image. There are four minimal configurations using point and line features: 3 points, 2 points and 1 line, 1 point and 2 lines, 3 lines. The first and the last scenarios that depend solely on either points or lines have been studied a few decades earlier. However the mixed scenarios, which are more common in practice, have not been solved yet. In

this paper we show that it is indeed possible to develop a general technique that can solve all four scenarios. The centerpiece of our method is a simple and generic method that uses collinearity and coplanarity constraints for solving the pose. In addition to validating the performance of these algorithms in simulations, we also show a compelling application for geo-localization using image sequences and coarse (plane-based) 3D models of GPS-challenged urban canyons.

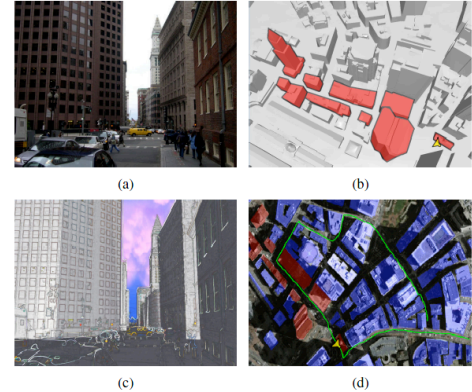

## Entropy Rate Superpixel Segmentation

Citation: Liu, M-Y, Tuzel, O.; Ramalingam, S.; Chellappa, "Entropy Rate Superpixel Segmentation", *IEEE Computer Vision & Pattern Recognition (CVPR)*, DOI: 10.1109/CVPR.2011.5995323, pp. 2097-2104, June 2011

Contacts: O. Oncel Tuzel, Srikumar Ramalingam

We propose a new objective function for super-pixel segmentation. This objective function consists of two components: entropy rate of a random walk on a graph and a balancing term. The entropy rate favors formation of compact and homogeneous clusters, while the balancing function encourages clusters with similar sizes. We present a novel graph construction for images and show that this construction induces a matroid—a combinatorial structure that generalizes the concept of linear independence in vector spaces.

The segmentation is then given by the graph topology that maximizes the objective function under the matroid constraint. By exploiting sub-modular and monotonic properties of the objective function, we develop an efficient greedy algorithm. Furthermore, we prove an approximation bound of  $1/2$  for the optimality of the solution.

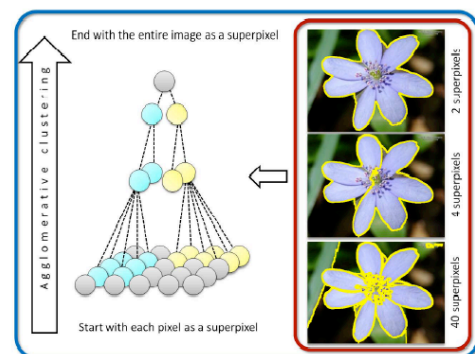

# Mechatronics

The Mechatronics group conducts fundamental and applied research and develops advanced technology in the areas of mechatronic systems and control, merging advanced control theory, dynamical systems theory, physics, computer science, mechanical engineering, optics, embedded systems, and power electronics, all with the intent to expand the performance envelope of Mitsubishi Electric products. The Mechatronics Group has expertise in multivariable, nonlinear, optimal & model-predictive control theory, nonlinear estimation, nonlinear dynamical systems, mechanical design, laser processing & sensing, 3D CAD and rapid prototyping. The group is growing its research and development portfolio in these areas, with an emphasis on control systems and dynamical systems. The business drivers for this R&D program are twofold. First, the design and control of electromechanical systems is central to many areas of Mitsubishi Electric's business. Second, with the rapidly increasing power of embedded computation and sensing technologies, there is the opportunity for synergy among research in mechatronics and control and MERL's existing research strengths in computer and information technology.

Automatic control systems take real-time measurements of a system under control, process the information with a control algorithm, and apply the results of the calculation back to the system under control via actuators. MERL's research focuses on development of new control algorithms that provide higher performance than the state-of-the-art. Recent results include more energy efficient air conditioners and servomotors, more precise laser processing systems, smoother riding elevators, and low-fuel mission plans for space probes. MERL's expertise includes optimal control, nonlinear control, adaptive and learning control, distributed control, and model-predictive control. MERL also conducts fundamental research to develop new control theory for general purpose use, with a strong interest in model predictive and adaptive control theories.

A dynamical system is one described by differential or difference equations. MERL's interest is to improve the performance of MELCO products and technology through the application of nonlinear dynamical systems theory. Applied research interests include mixing in fluids and the design of minimum-fuel trajectories for space probes, both of which exploit nonlinearity and chaos in highly creative and deeply mathematical ways.

## Recent Research

Modeling Current Forces for 5-Axis Machining of Sculptured Surfaces.....	68
End to End Optimization of Low-Energy Lunar Missions.....	68
A Parallel Quadratic Programming Algorithm for Model Predictive Control .....	69
Nonlinear Control Design for Semi-Active Vibration Reduction System.....	69
On the Optimal Trajectory Generation for Servomotors: A Hamiltonian Approach .....	70
High Accuracy Computation of Geometric Properties of Cutter Workpiece Intersection ... ..	70
High Accuracy NC Milling Simulation Using Composite Adaptively Sampled Distance Fields	71
An Industry Perspective on MPC in Large Volumes Applications: Potential Benefits ... ..	71
Efficient Estimation and Uncertainty Quantification in Space Mission Dynamics.....	72
Extremum Seeking Control for Energy Optimization of Vapor Compression Systems .....	72
Topological Chaos, Braiding and Bifurcation of Almost-cyclic Sets.....	73

## Modeling Current Forces for 5-Axis Machining of Sculptured Surfaces

Citation: Boz, Y.; Erdim, H.; Lazoglu, I., "Modeling Cutting Forces for 5-Axis Machining of Sculptured Surfaces", *International Conference Process Machine Interactions*, Scientific Session C-Metal Cutting Process, June 2010

Contacts: Huseyin Erdim

5-axis milling processes are used widely in various industries such as aerospace, die-mold and biomedical industries where surface quality and integrity is important and the production tolerances are very tight. Therefore, improving surface quality and integrity without sacrificing productivity is crucial in these industries. Improvements in CAD/CAM, cutting tool and the machine tool technologies

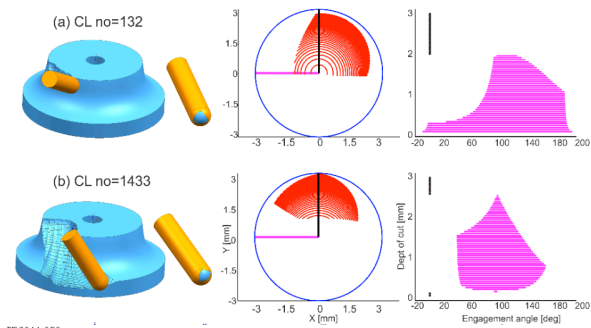

allow the production of high precision parts in less cycle times. However, desired quality and productivity can be obtained if process parameters such as feedrate, spindle speed, axial and radial depth of cut are selected appropriately. In general, these parameters are selected conservatively based on engineering expertise or trial and error methods in order to prevent work piece, or cutter of the machine to be damaged. Therefore, virtual machining simulation for milling processes is an increasing demand before the production of the part. This paper presents a mechanistic cutting force model for 5-axis ball-end milling process simulation. Cutter/work piece engagement is determined via newly developed solid modeler based engagement model. Validation tests demonstrate that presented model is computationally efficient and force predictions are in good agreement with the experimental data.

## End to End Optimization of Low-Energy Lunar Missions

Citation: Grover, P.; Andersson, C., "End to End Optimization of Low-Energy Lunar Missions", *American Astronautical Society (AAS) American Institute of Aeronautics and Astronautics (AIAA)*, January 2012

Contacts: Piyush Grover

We describe a modular optimization framework for GTO-to-moon mission design using the planar circular restricted three-body problem (PCR3BP) model. The three-body resonant gravity assists and invariant manifolds in the planar restricted three-body problem are used as basic building blocks of this mission design. The mission is optimized by appropriately timed delta-Vs, which are obtained by a shooting method and a Gauss-Pseudospectral collocation method for different phases of the mission. Depending upon the initial and final orbits, the optimized missions consume between 10-15 % less fuel compared to a Hohmann transfer, while taking around 4 to 5 months of travel time.

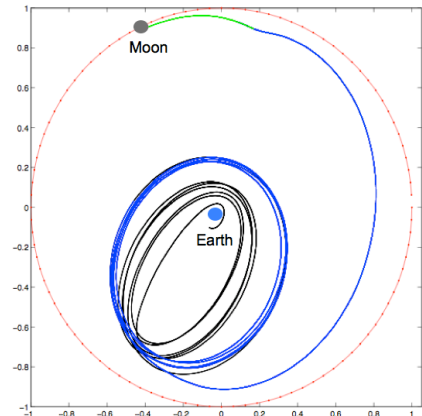



## A Parallel Quadratic Programming Algorithm for Model Predictive Control

Citation: Brand, M.; Shilpiekandula, V.; Bortoff, S.A., "A Parallel Quadratic Programming Algorithm for Model Predictive Control", *International Federation of Automatic Control (IFAC)*, Vol. 18, Part 1, August 2011

Contacts: Matthew E. Brand, Scott A. Bortoff

In this paper, an iterative multiplicative algorithm is proposed for the fast solution of quadratic programming (QP) problems that arise in the real-time implementation of Model Predictive Control (MPC). The proposed algorithm--Parallel Quadratic Programming (PQP)--is amenable to fine-grained parallelization. Conditions on the convergence of the PQP algorithm are given and proved. Due to its extreme simplicity, even serial implementations offer considerable speed advantages. To demonstrate, PQP is applied to several simulation examples, including a stand-alone QP problem and two MPC examples. When implemented in MATLAB using single-thread computations, numerical simulations of PQP demonstrate a 5 - 10x speed-up compared to the MATLAB active-set based QP solver quadprog. A parallel implementation would offer a further speed-up, linear in the number of parallel processors.

### Model Predictive Control Algorithm

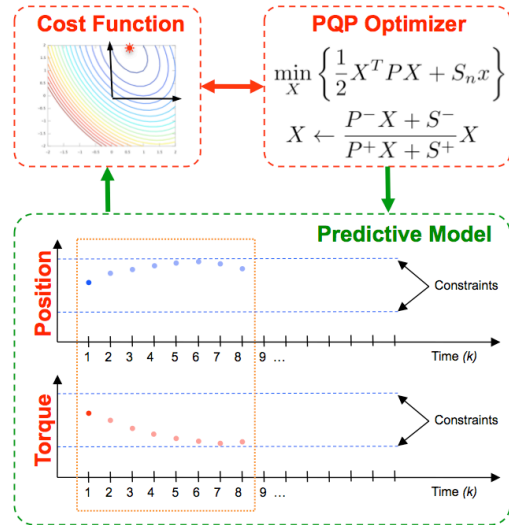

## Nonlinear Control Design for Semi-Active Vibration Reduction System

Citation: Wang, Y.; Utsunomiya, K.; Bortoff, S.A., "Nonlinear Control Design for a Semi-active Vibration Reduction System", *Chinese Control Conference (CCC)*, pp. 5833-5837, July 2011

Contacts: Yebin Wang, Scott A. Bortoff

This paper considers the control design for a vibration reduction system using semi-active actuators to improve the ride quality. The main challenges come from the nonlinear dynamics, limited control authority, and lack of performance-oriented nonlinear control design results. Two nonlinear controllers are proposed and compared to a conventional semi-active control. Simulation shows the proposed controls provide a good balance of metrics.

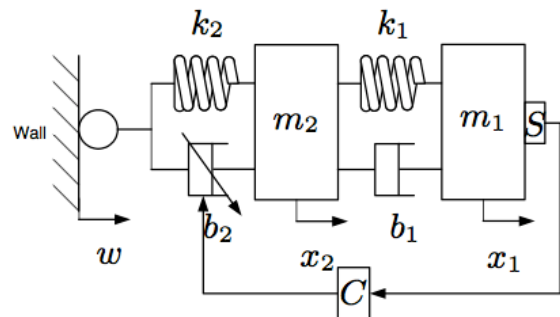

## On the Optimal Trajectory Generation for Servomotors: A Hamiltonian Approach

Citation: Wang, Y.; Ueda, K.; Bortoff, S.A., “On the Optimal Trajectory Generation for Servomotors: A Hamiltonian Approach”, IEEE Annual Conference on Decision and Control (CDC), ISSN: 7620-7625, pp. 7620-7625, December 2012

Contacts: Yebin Wang, Scott A. Bortoff

This note considers the energy optimal trajectory control design approach. Solving the exact optimal solution is challenging because of the nonlinear and switching cost function, and various constraints. The minimum principle is applied to establish piecewise necessary optimality conditions. An approximate optimal control is proposed to circumvent the difficulty due to the nonlinearity of the cost function. Simulation is performed to illustrate the generation of the approximate optimal trajectory.

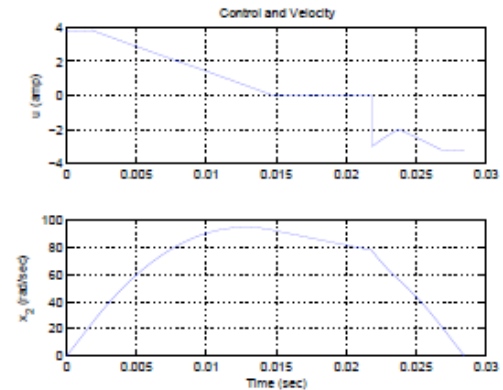

Fig. 3. Case 2: the trajectories of control and velocity

## High Accuracy Computation of Geometric Properties of Cutter Workpiece Intersection using Distance Fields for NC Milling

Citation: Erdim, H.; Sullivan, A., “High Accuracy Computation of Geometric Properties of Cutter Workpiece Intersection using Distance Fields for NC Milling”, CIRP Conference on Process Machine Interactions (PMI), Vol. 4, pp. 84-89, October 2012

Contacts: Huseyin Erdim, Alan Sullivan

Composite adaptively sampled distance fields (caDF) are a new approach to shape representation that is well suited for shapes moving along a given path for NC milling. A caDF consists of a set of analytic or procedurally defined distance fields associated with both the original unmilled workpiece and with the volumes swept by milling tools as they move along their prescribed path. An octree bounding volume hierarchy is used to sample the distance functions and provides spatial localization of geometric operations thereby dramatically increasing the speed of the system. The resulting representation is fast to determine, provides high reconstruction accuracy, and requires relatively low memory. In this paper, we provide a brief introduction to caDFs and describe a new method for determining the engagement surface between a moving tool and workpiece, and calculate the geometric properties of the removed volume.

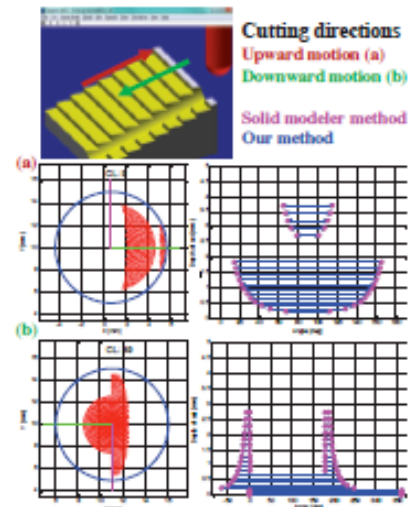

Fig. 9. The top view of engagement surfaces and angle of engagement for Ball-end mill tool; (a) Upward motion, (b) Downward motion.

## High Accuracy NC Milling Simulation Using Composite Adaptively Sampled Distance Fields

Citation: Sullivan, A.; Erdim, H.; Perry, R.N.; Frisken, S.F., “High Accuracy NC Milling Simulation Using Composite Adaptively Sampled Distance Fields”, *Computer-Aided Design*, Vol. 44, Issue 6, pp. 522-536, June 2012

Contacts: Alan Sullivan, Huseyin Erdim, Ronald N. Perry

We describe a new approach to shape representation called a composite adaptively sampled distance field (composite ADF) and describe its application to NC milling simulation. In a composite ADF each shape is represented by an analytic or procedural signed

Euclidean distance field and the milled workpiece is given as the Boolean difference between distance fields representing the original workpiece volume and distance fields representing the volumes of the milling tool swept along the prescribed milling path. The computation of distance field of the swept volume of a milling tool is handled by an inverted trajectory approach where the problem is solved in tool coordinate frame instead of a world coordinate frame.

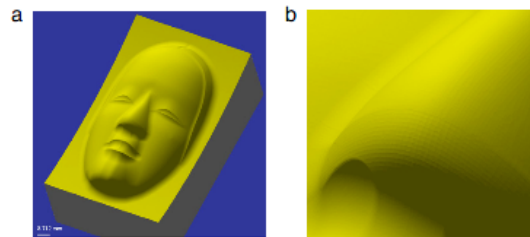

Fig. 14. (a) Image of the whole finished Japanese Noh mask simulation and (b) a close-up simulation image of the nose of the simulated workpiece

## An Industry Perspective on MPC in Large Volumes Applications: Potential Benefits and Open Challenges

Citation: Di Cairano, S., “An Industry Perspective on MPC in Large Volumes Applications: Potential Benefits and Open Challenges”, *IFAC Nonlinear Model Predictive Control Conference (NMPC)*, August 2012

Contacts: Stefano Di Cairano

Model predictive control has been originally developed for chemical process control, where plants are expensive, have slow dynamics, and a large number of inputs and outputs.

Furthermore, in chemical process control each control system is usually deployed to a single plant, and hence can be specifically tuned. In recent years there has been a growing interest towards MPC in other industries, where the plants have faster dynamics, fewer inputs and outputs, reduced costs, and each controller is deployed in large volumes. In this paper we discuss the benefits of MPC in large volumes industries, by using examples from automotive, aerospace, and mechatronics that also present several specific nonlinearities that can be efficiently handled by MPC.

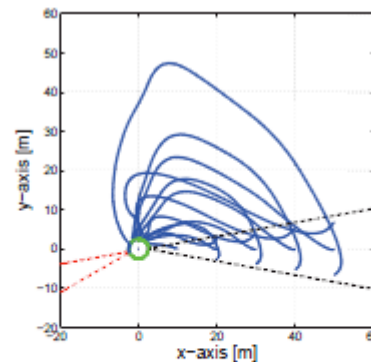

Fig. 4. Radial approach trajectories from various initial positions for a spacecraft docking to a rotating platform within the (rotating) LoS cone (initial position in black dashed lines, final position in the red dashed lines, counterclockwise rotation).

## Efficient Estimation and Uncertainty Quantification in Space Mission Dynamics

Citation: Grover, P.; Sato, Y., “Efficient Estimation and Uncertainty Quantification in Space Mission Dynamics”, AIAA/AAS Astrodynamics Specialist Conference, DOI: 10.2514/6.2012-5062, August 2012

Contacts: Piyush Grover

The problem of efficient and accurate orbit estimation of space trajectories is discussed. For highly sensitive low-fuel trajectories designed to exploit the complex nonlinear dynamics of the three-body problem, it is vital to have accurate state estimation during maneuvers and ability to deal with irregular observation update times. For instance, in Halo-orbit insertion and station keeping maneuvers, state estimation errors can propagate quickly. In this paper, we combine an efficient probability propagation method with a homotopy-based posterior computation method. The resulting particle filter is highly accurate even in highly nonlinear regime with intermittent observations, and yet an order of magnitude or more efficient than a generic particle filter implementation.

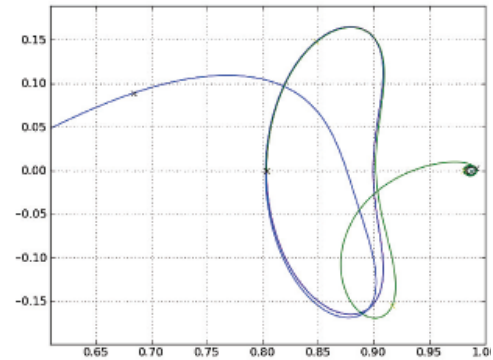

Figure 4. Insertion into (blue) and out of (green) a Restricted Three-Body Problem.

## Extremum Seeking Control for Energy Optimization of Vapor Compression Systems

Citation: Burns, D.J.; Laughman, C.R., “Extremum Seeking Control for Energy Optimization of Vapor Compression Systems”, International Refrigeration and air Conditioning Conference at Purdue, ID: 2192, July 2012

Contacts: Daniel J. Burns, Christopher R. Laughman

In this paper, an energy optimizing extremum seeking controller is developed for vapor compression systems (VCS) that automatically discovers sets of inputs that minimizes the energy consumption while the machine is in operation. This controller optimizes an input-output map (from VCS inputs to electrical energy consumed) in realtime, and without relying on a model of the dynamics of a vapor compression system. A detailed algorithm and rules for tuning the controller gains will be described. Experiments are performed on an inverter-driven room air conditioner that demonstrate convergence of inputs to their optimal values, resulting in an improvement in COP of 10-20% for some operating points.

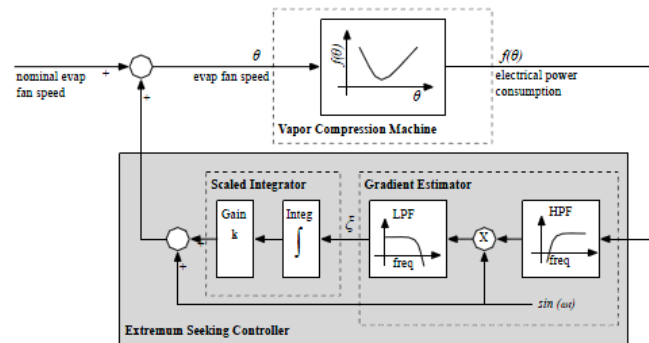

Figure 2: The extremum seeking algorithm consists of a gradient estimator and a scaled integrator. This controller perturbs one input to the vapor compression system, and uses the response to that perturbation to drive the inputs in the direction that minimizes electrical power consumption.

## Topological Chaos, Braiding and Bifurcation of Almost-cyclic Sets

Citation: Grover, P.; Ross, S.; Stremier, M.; Kumar, P., "Topological Chaos, Braiding and Bifurcation of Almost-cyclic Sets", AIP Chaos, Vol. 22, Issue 4, December 2012

Contacts: Piyush Grover

In certain two-dimensional time-dependent flows, the braiding of periodic orbits provides a way to analyze chaos in the system through application of the Thurston-Nielsen classification theorem (TNCT). We expand upon earlier work that introduced the application of the TNCT

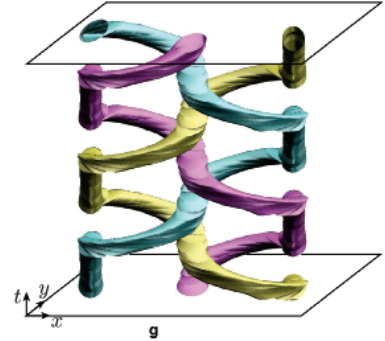
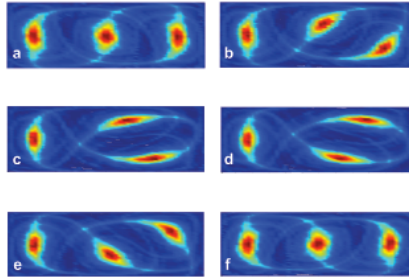

FIG. 9. Braiding in  $(2 + 1)$ -dimensional space-time via three almost-cyclic sets for  $\tau_j \approx 0.975$ , a parameter value for which corresponding periodic points no longer exist. The 2nd eigenvector,  $v_2$ , of  $Re \lambda_j$  is shown for different phases for the first half-period, specifically  $t/\tau_j =$  (a) 0, (b) 0.1, (c) 0.2, (d) 0.3, (e) 0.4, (f) 0.5. (g) The 3 ACSs shown braiding in space-time for 3 periods of flow. The braid is isotopic to the braid shown in Figure 1(c) (enhanced online) [URL: <http://dx.doi.org/10.1063/1.4768666.1>] [URL: <http://dx.doi.org/10.1063/1.4768666.2>].

to braiding of almost-cyclic sets, which are individual

components of almost-invariant sets [Stremier et al., "Topological chaos and periodic braiding of almost-cyclic sets", Phys. Rev. Lett. 106, 114101 (2011)]. In this context, almost-cyclic sets are periodic regions in the flow with high local residence time that act as stirrers or "ghost rods" around which the surrounding fluid appears to be stretched and folded. In the present work, we discuss the bifurcation of the almost-cyclic sets as a system parameter is varied, which results in a sequence of topologically distinct braids. We show that, for Stokes' flow in a lid-driven cavity, these various braids give good lower bounds on the topological entropy over the respective parameter regimes in which they exist. We make the case that a topological analysis based on spatiotemporal braiding of almost-cyclic sets can be used for analyzing chaos in fluid flows. Hence, we further develop a connection between set-oriented statistical methods and topological methods, which promises to be an important analysis tool in the study of complex systems.



# Algorithms

Researchers in the Algorithms group at MERL develop solution methods for optimization problems involving very large numbers of variables. Typically these arise in inference problems involving images, video, or audio; network transport problems; coding and compression problems; or design problems. Usually these problems are characterized by very complicated probability distributions in extremely high dimensional spaces. Because classical approaches to these problems are infeasible, our results can open new business opportunities where there are no competitive technologies. Another main research theme involves adaptively-sampled distance fields, providing superior font and graphical rendering for digital displays.

Most of the group's work revolves around graph-based optimizations and inference, where the graph is a representation of the problem constraints and a probability distribution over possible solutions. Through formal analysis we identify tractable estimation or approximation schemes. This meshes with MERL's expertise in fields and technologies such as belief propagation, machine learning, computer vision, dynamic programming, convex optimization, coding and communications theory, and signal processing.

## Recent Research

Hierarchical and High-Girth QC LDPC Codes .....	76
Cooperative Routing for Wireless Networks Using Mutual-Information Accumulation.....	76
Image and Video Retargeting by Darting .....	77
Designing with Distance Fields .....	77
Stochastic Shortest Paths Via Quasi-convex Maximization.....	78
Parallel Quadratic Programming for Image Processing.....	78

## Hierarchical and High-Girth QC LDPC Codes

Citation: Wang, Y.; Draper, S.C.; Yedidia, J.S., "Hierarchical and High-Girth QC LDPC Codes", IEEE Transactions on Information Theory, ISSN: 0018-9448, Vol. 59, Issue 7, pp. 453-4583, March 2013  
 Contacts: Kieran J. Parsons

We present an approach to designing capacity-approaching high-girth low-density parity-check (LDPC) codes that are friendly to hardware implementation, and compatible with some desired input code structure defined using a protograph. The approach is based on a mapping of any class of codes defined using a protograph into a family of hierarchical quasicyclic (HQC) LDPC codes. Whereas the parity check matrices of standard quasi-cyclic (QC) LDPC codes are composed of circulant sub-matrices, those of HQC LDPC codes are composed of a hierarchy of circulant sub-matrices that are in turn constructed from circulant sub-matrices, and so on, through some number of levels. Next, we present a girth-maximizing algorithm that optimizes the degrees of freedom within the family of codes to yield a high-girth HQC LDPC code, subject to bounds imposed by the fact that that HQC codes are still quasi-cyclic. Finally, we discuss how certain characteristics of a code protograph will lead to inevitable short cycles, and show that these short cycles can be eliminated using a "squashing" procedure that results in a high-girth QC LDPC code, although not a hierarchical one. We illustrate our approach with three design examples of QC LDPC codes -- two girth-10 codes of rates 1/3 and 0.45 and one girth-8 code of rate 0.7.



## Cooperative Routing for Wireless Networks Using Mutual-Information Accumulation

Citation: Draper, S.C.; Liu, L.; Molisch, A.F.; Yedidia, J.S., "Cooperative Routing for Wireless Networks using Mutual-Information Accumulation", *The Smithsonian/NASA Astrophysics Data System*, eprint arXiv:0908.3886, August 2009  
 Contacts: Jonathan Yedidia

Cooperation between the nodes of wireless multihop networks can increase communication reliability, reduce energy consumption, and decrease latency. The possible improvements are even greater when nodes perform mutual information accumulation using rateless codes. In this paper, we investigate routing problems in such networks. Given a network, a source, and a destination, our objective is to minimize end-to-end transmission delay under energy and bandwidth constraints. We provide an algorithm that determines which nodes should participate in forwarding the message and what resources (time, energy, and bandwidth) should be allocated to each.

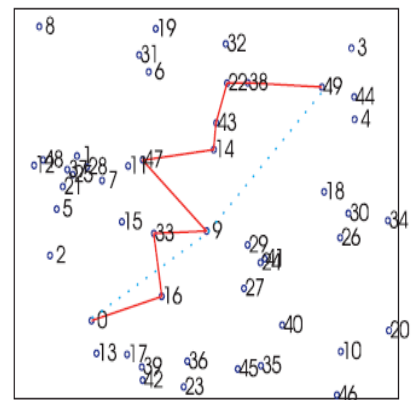



## Image and Video Retargeting by Darting

Citation: Brand, M., "Image and Video Retargetting by Darting", *Image Analysis and Recognition*, ISBN: 978 3 642 02610 2, Vol. 5627/2009, pp. 33-42, July 2009

Contact: Matt Brand

We consider the problem of altering an image by imperceptibly adding or removing pixels, for example, to fit a differently shaped frame with minimal loss of interesting content. We show how to construct a family of convex programs that suitably rearrange pixels while minimizing image artifacts and distortions. We call this “darting” on analogy to a tailor’s darts—small edits are discreetly distributed throughout the fabric of the image. We develop a reduction to integer dynamic programming on edit trellises, yielding fast algorithms. One- and two-pass variants of the method have  $O(1)$  per-pixel complexity. Of the many edits that darting supports, five are demonstrated here: image retargeting to smaller aspect ratios; adding or moving or removing scene objects while preserving image dimensions; image expansion with gaps filled by a rudimentary form of texture synthesis; temporal video summarization by “packing” motion in time; and an extension to spatial video retargeting that avoids motion artifacts by preserving optical flow.



## Designing with Distance Fields

Citation: Frisken, S.F.; Perry, R.N., "Designing with Distance Fields", *ACM SIGGRAPH*, ISBN: 1-59593-364-6, pp. 60-66, July 2006

Contacts: Ronald Perry

Distance fields provide an implicit representation of shape that has advantages in many application areas; in this overview, we focus on their use in digital design. Distance fields have been used in Computer Aided Design since the 1970's (e.g. for computing offset surfaces and for generating rounds and filets). More recently, distance fields have been used for freeform design where their dual

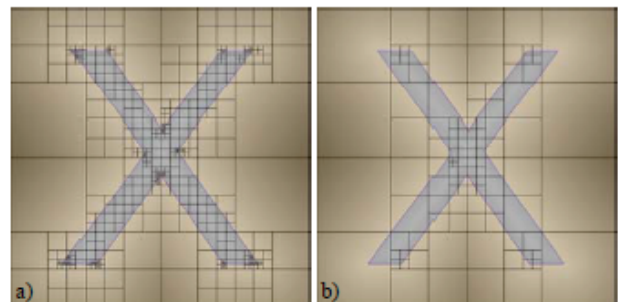

nature of providing both a volumetric representation and a high-quality surface representation provides a medium that has some of the properties of real clay. Modern computer systems coupled with efficient representations and methods for processing distance fields have made it possible to use distance fields in interactive design systems. This overview reviews previous work in distance fields, discusses the properties and advantages of distance fields that make them suitable for digital design, and describes Adaptively Sampled Distance Fields (ADFs), a distance field representation capable of representing detailed, high quality, and expressive shapes. ADFs are both efficient to process and have a relatively small memory footprint.

## Stochastic Shortest Paths Via Quasi-convex Maximization

Citation: Nikolova, E.; Kelner, J.; Brand, M.; Mitzenmacher, M., "Stochastic Shortest Paths Via Quasi-convex Maximization", *ESA 2006*, ISBN:3-540-38875-3, Pp 552 - 563 , September 2006

Contacts: Matthew Brand

We consider the problem of finding shortest paths in a graph with independent randomly distributed edge lengths. Our goal is to maximize the probability that the path length does not exceed a given threshold value (deadline). We give a surprising exact  $n^{\theta(\log n)}$  algorithm for the case of normally distributed edge lengths, which is based on quasi-convex maximization. We then prove average and smoothed polynomial bounds for this algorithm, which also translate to average and smoothed bounds for the parametric shortest path problem, and extend to a more general non-convex optimization setting. We also consider a number of other edge length distributions, giving a range of exact and approximation schemes.

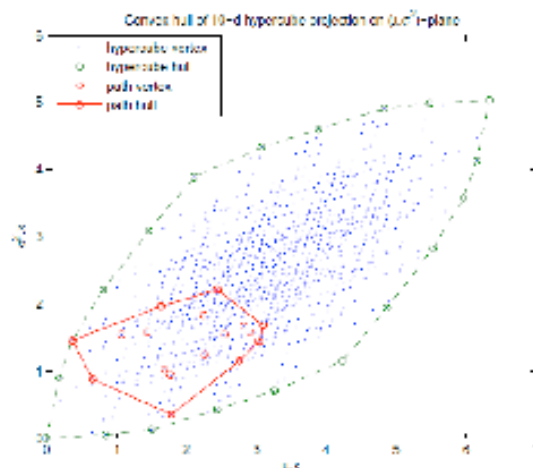

## Parallel Quadratic Programming for Image Processing

Citation: Brand, M.; Chen, D., "Parallel Quadratic Programming for Image Processing", *IEEE International Conference on Image Processing (ICIP)*, DOI: 10.1109/ICIP.2011.6116089, pps. 2261-2264, September 2011

Contacts: Matthew E. Brand

Many image processing and computer vision problems can be solved as quadratic programs in the non-negative cone. This paper develops a provably convergent multiplicative update that has a simple form and is amenable to fine-grained data parallelism. Classic algorithms for deblurring, matrix factorization, and tomography are recovered as special cases. This paper also demonstrates applications to super-resolution, labeling and segmentation.

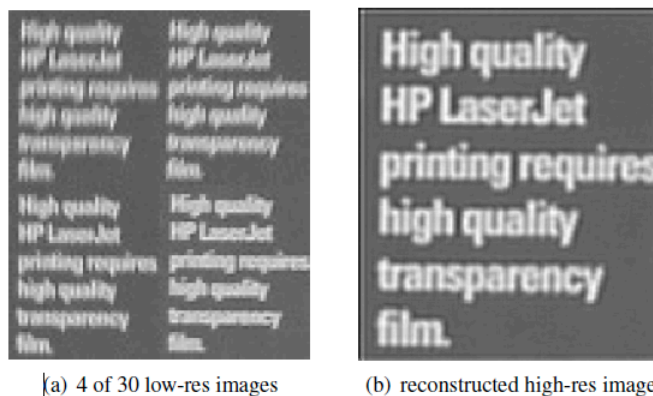

**Fig. 1.** Super-resolution example: a) 4 of 30 low-res images; b) the reconstruction high-res image obtained by solving SR model (6) with the multiplicative update.